



V A N D E R H A L L



Venice OWNERS' MANUAL

The Vanderhall Venice is NOT a car.

The Vanderhall Venice complies with Federal Motor Vehicle Safety Standards (FMVSS) and regulations of the United States Department of Transportation (DOT) applicable to motorcycles in the USA.

The Vanderhall Venice vehicle does NOT comply with Federal Motor Vehicle Safety Standards (FMVSS) and regulations of the United States Department of Transportation (DOT) applicable to passenger cars in the USA.

Always wear a helmet when operation or riding in a Vanderhall Venice.

Introduction	6	Driving and Operation	52
Quick Overview	10	Vehicle Care	69
Seats and Restraints.....	21	Service and Maintenance.....	105
Instruments and Controls	28	Customer Information.....	114
Lighting	44		

Introduction



Introduction



VANDERHALL

The names, logos, emblems, slogans, vehicle model name, and vehicle body designs appearing in this manual including, but not limited to, Vanderhall and Venice are trademarks of Vanderhall Motorworks.

Using this Manual

To quickly locate information about the vehicle, use the Index in the back of the manual. It is an alphabetical list of what is in the manual and the page number where it can be found.

Danger, Warning, and Caution

Warning messages found on vehicle labels and in this manual describe hazards and what to do to avoid or reduce them.

! Danger

Danger indicates a hazard with a high level of risk which will result in serious injury or death

! Warning

Warning indicates a hazard that could result in injury or death

Caution

Caution indicates a hazard that could result in property or vehicle damage

Symbols

Your Vanderhall Venice has components and labels that utilize symbols instead of text. Symbols are often shown with text describing the operation or information related to a specific component, control, message, gauge, or indicator



: Shown when the owner manual contains additional instructions or information.

Vehicle symbol Chart

ABS : Antilock Brake System

Brake : Brake System Warning Light

TC : Traction Control



: Do Not Puncture



: Do Not Service



: Engine Coolant Temperature



: Flame/Fire Prohibited



: Fuel Gauge



: Fuses



: Headlamp High/Low-Beam Changer



: Malfunction Indicator Lamp



: POWER



: Under Pressure

Quick Overview



Quick Overview

		Power Outlet	19
		Trunk	19
Instrument Panel		Performance	
Instrument Panel Introduction	12	Traction Control	19
Introduction to vehicle features			
Seat Adjustment	15		
Heated Seats	15		
Safety Belts	15		
Mirror Adjustments	16		
Steering Wheel Adjustment	16		
Climate Control	16		
Transmission	17		
Manual Mode	17		
Starting the Engine	17		
Vehicle Features			
Stereo Bluetooth® Audio	18		
Cruise Control	18		

12
Instrument Panel

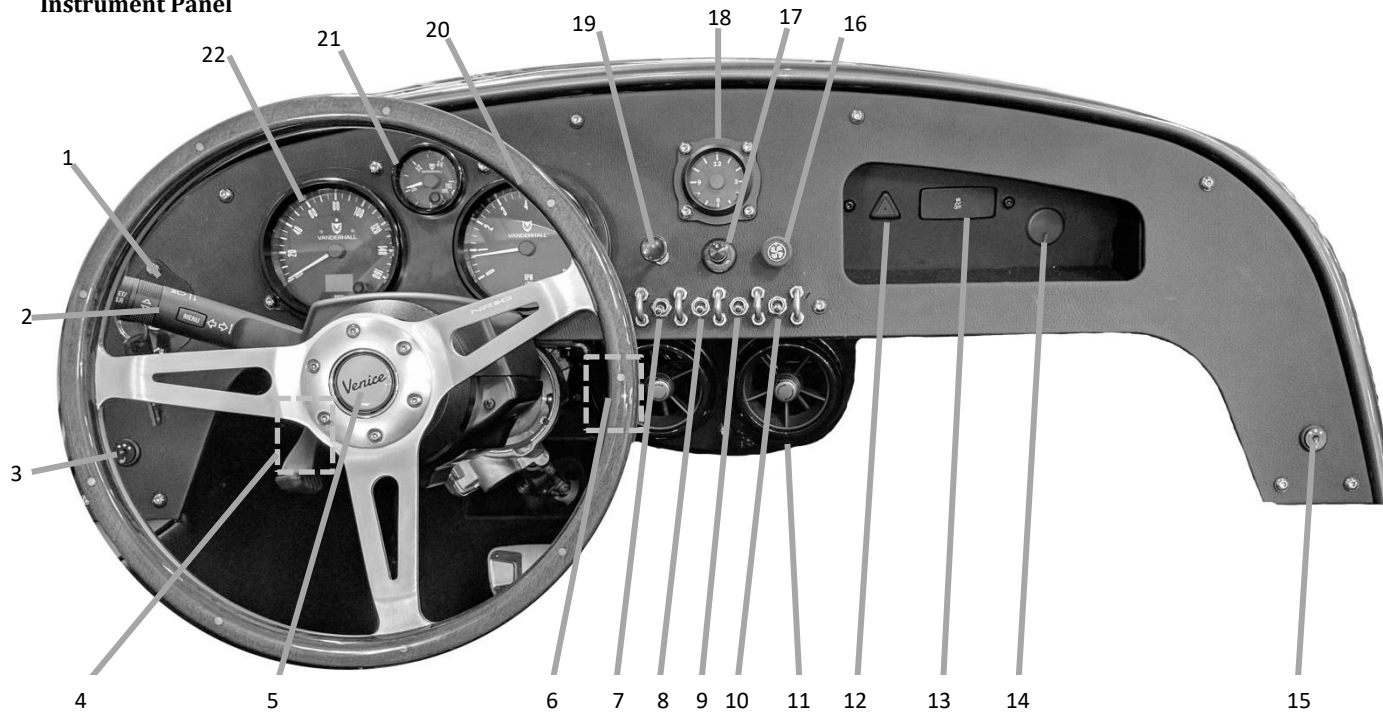

13

1. Ignition Switch
2. Turn Signal Lever, High Beam Switch
3. Driver Heated Seat Control
4. Steering Wheel Adjustment
5. Horn
6. Data Link Connector (Under Dash)
7. Cruise Control Activation
8. Cruise Control Speed Adjustment
9. Unused
10. Unused
11. Air Vent
12. Hazard Warning Flashers
13. Traction Control
14. Accessory Power Port
15. Passenger Heated Seat Control
16. Heater Fan Speed
17. Bluetooth Audio Controls
18. Temperature Gauge or Optionally a Clock
19. Heater Temperature Control
20. Tachometer
21. Fuel Gauge
22. Speedometer

Quick Start Guide

Start



1. Shift position in park
2. Insert key
3. Depress brake pedal
4. Turn key clockwise to start

Drive

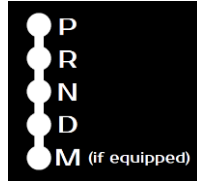

1. Depress brake pedal
2. Push down on shifter
3. Shift to D
4. Release Brake



Stereo

1. Push knob to pair Bluetooth device
2. Search on device and pair to WW-BT-VC
3. Hold left/right for volume control
4. Quick turn knob to advance song

Heater

1. Turn fan dial to the right to turn on and adjust speed.
2. Push black knob for vent and pull for heater

Seats



1

2

1. Seat Adjustment Handle
2. Safety Belt Latch

Seat Adjustment

To adjust the seat

1. Pull the handle at the front of the seat
2. Slide the seat to the desired position and release the handle
3. Try to move the seat back and forth to ensure it is locked in place

Heated Seats

To Turn on the heated seats press the button. Three lights will appear on the button indicating the heater is on High heat

Press a second time 2 lights will appear on the button indicating Medium heat

Pressing the button a third time 1 light will be illuminated indicating Low heat

Pressing the button a fourth time will turn the Heated seats off

HEATED SEATS ⇨ 23

Safety Belts



Refer to the following sections for important information on how to use safety belts properly:

SAFETY BELTS ⇨ 24.

HOW TO WEAR SAFETY BELTS PROPERLY ⇨ 25.

Mirror Adjustment

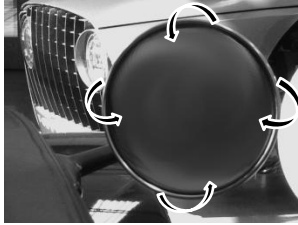

The Mirrors are manually adjustable.

To adjust mirror:

1. Grasp mirror on the edge
2. Rotate to desired position

Steering Wheel Adjustment



To adjust the steering wheel:

1. Pull the lever down.
2. Move the steering wheel up, down, forward, and backward.
3. Pull the lever up to lock the steering wheel in place.

Do not adjust the steering wheel while driving.

SEE STEERING WHEEL ADJUSTMENT ⇨ 30

Climate Control

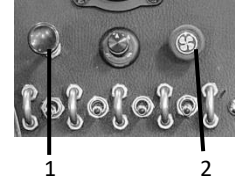

1. Temperature Control
2. Fan Speed Control

Pushing and pulling the Temperature control lever will raise and lower the temperature of the air exiting the Air Vents

The climate control fan has four speeds. These can be changed by turning the Fan Speed Control dial

SEE CLIMATE CONTROL ⇨ 40

Transmission



Your Vanderhall Venice is equipped with an automatic transmission. With the following pattern, starting at the forward most position.

- Park
- Reverse
- Neutral
- Drive
- Manual (Optional)

SEE TRANSMISSION ⇨ 58

Manual Mode

Manual Mode is an optional feature, if equipped. This feature allows you to manually select gears using the Bump Shifter located on the Driver Sill

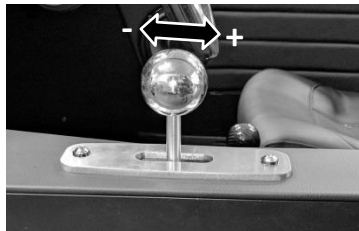

To activate Manual Mode

1. Push the shift lever down
2. Pull the shift lever from Drive to Manual
3. Pull the Bump Shift handle toward you to up shift
4. Push the Bump Shift handle away from you Down Shift

SEE MANUAL MODE ⇨ 59.

Starting the Engine

The vehicle has a Computer-Controlled Cranking System. It assists in starting the engine and protects components. If the ignition key is turned to START and then released when the engine begins cranking, the engine will continue cranking for a few seconds or until the engine starts. If the engine does not start and the key is held in START, cranking will be stopped after 15 seconds to prevent damage. To prevent gear damage, cranking is not allowed if the engine is running. Engine cranking can be stopped by turning the ignition key to ACC/ACCESSORY or LOCK/OFF.

SEE STARTING THE ENGINE ⇨ 55.

Vehicle Features

Stereo Bluetooth® Audio

The Bluetooth® system allows users with a Bluetooth-enabled device to play audio on the vehicle speakers.

SEE BLUETOOTH ⇒ 42

Cruise Control

Cruise Control is an optional feature. This section will describe its operation if it has been equipped.



- 1 Cruise Control Activation
- 2 Cruise Control Speed Adjust

Cruise Control Activation: Flip the switch to the up position to activate Cruise Control. Return the switch to the down position to deactivate Cruise Control

Cruise Control Speed Adjust Up Position, (Resume/Accelerate): If there is a set speed in memory, move the switch up briefly to resume to that speed or hold upward to accelerate. If cruise control is already active, use to increase vehicle speed.

Cruise Control Speed Adjust Down Position, (Set/Coast): Move the switch down briefly to set the speed and activate cruise control. If cruise control is already active, use to decrease speed.

SEE CRUISE CONTROL ⇒ 63.

Power Outlet

The accessory power outlets can be used to plug in electrical equipment, such as a cell phone. The vehicle has an accessory power outlet in the accessory tray on the passenger side of dash.

SEE POWER OUTLETS ⇨ 30



Trunk

To access the Trunk, slide either the driver or passenger seat forward.

Performance

Traction Control

The Traction Control System (TCS) limits wheel spin. The system is on when the vehicle is started.

- To turn off traction control, press and release the TCS button  in the accessory tray. The traction off light **TC** illuminates. Press and release the TCS button  again to turn traction control back on.

SEE TRACTION CONTROL ⇨ 61

Seats and Restraints



21

Seats and Restraints

Seats

Seat Adjustment

23

Heated Seats

23

Safety Belts

Why Safety Belts Work

24

How to Wear Safety
Belts Properly

25

Securing Lap and
Shoulder Belt

25

Unlatching Lap and
Shoulder Belt

26

Seats

Seat Adjustment

! Warning

You can lose control of the vehicle if you try to adjust a driver seat while the vehicle is moving. Adjust the driver seat only when the vehicle is not moving.

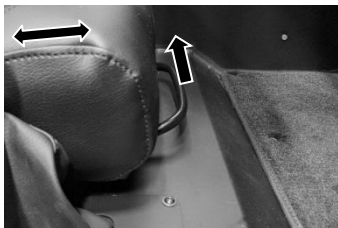

To adjust the seat:

1. Pull up on the handle at the front of the seat.

2. Slide the seat to the desired position and release the handle.
3. Try to move the seat back and forth to be sure it is locked in place.

Heated Seats

! Warning

If you cannot feel temperature change or pain to the skin, the seat heater may cause burns. To reduce the risk of burns, people with such a condition should use care when using the seat heater, especially for long periods of time. Do not place anything on the seat that insulates against heat, such as a blanket, cushion, cover, or similar item. This may cause the seat heater to overheat. An overheated seat heater may cause a burn or may damage the seat.

To Turn on the heated seats press the  button. Three lights will appear on the button indicating the heater is on High

Press a second time 2 lights will appear on the button indicating Medium heat

Pressing the button a third time 1 light will be illuminated indicating Low heat

Pressing the button a fourth time will turn the Heated seats off

Safety Belts

This section of the manual describes how to use safety belts properly. It also describes some things not to do with safety belts.

! Warning

Do not let anyone ride where a safety belt cannot be worn properly. In a crash, if you or your passenger(s) are not wearing safety belts, injuries can be much worse than if you are wearing safety belts. You can be seriously injured or killed by hitting things inside the vehicle harder or by being ejected from the vehicle. In addition, anyone who is not buckled up can strike other passengers in the vehicle.

It is extremely dangerous to ride in a cargo area, inside or outside of a
(Continued)

! Warning

Vehicle. In a collision, passengers riding in these areas are more likely to be seriously injured or killed. Do not allow passengers to ride in any area of the vehicle that is not equipped with seats and safety belts.

Always wear a safety belt, and check that all passenger(s) are restrained properly too.

Why Safety Belts Work

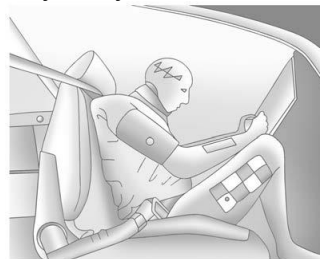

When riding in a vehicle, you travel as fast as the vehicle does. If the vehicle stops suddenly, you keep going until something stops you. It could be the windshield, the instrument panel, or the safety belts!

When you wear a safety belt, you and the vehicle slow down together. There is more time to stop because you stop over a longer distance and, when worn properly, your strongest bones take the forces from the safety belts. That is why wearing safety belts make such good sense.

How to Wear Safety Belts Properly

This section is only for people of adult size. Follow those rules for everyone's protection.

It is very important for all occupants to buckle up. Statistics show that unbelted people are hurt more often in crashes than those who are wearing safety belts. There are important things to know about wearing a safety belt properly

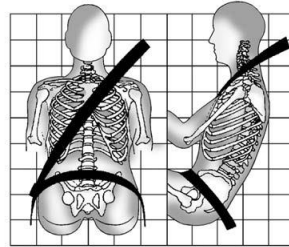

- Wear the lap part of the belt low and snug on the hips, just touching the thighs. In a crash, this applies force to the strong pelvic bones and you would be less likely to slide under the lap belt. If you slid under it, the belt would apply force on your abdomen. This could cause serious or even fatal injuries.
- Wear the shoulder belt over the shoulder and across the chest. These parts of the body are best able to take belt restraining forces. The shoulder belt locks if there is a sudden stop or crash.

! Warning

You can be seriously injured, or even killed, by not wearing your safety belt properly.

- Never allow the lap or shoulder belt to become loose or twisted.
- Never wear the shoulder belt under both arms or behind your back.

Securing Lap-Shoulder Belt

Both Driver and Passenger seats have a lap-shoulder belt. The following instructions explain how to wear a lap-shoulder belt properly.

1. Sit up straight
2. Grasp the latch plate and pull the belt across your body. Do not allow the belt to become twisted

3. If you pull rapidly the belt may lock. If this occurs allow the belt to retract slightly then continue pulling the belt across your body more slowly.
4. Push the latch plate in to the buckle until a click is heard
5. Pull on the latch plate to ensure it is secure.
6. To make the Lap Belt tight, pull up on the shoulder belt

Unlatching Lap and Shoulder Belt

To unlatch the belt, press the red button on the buckle. The belt will then return to its stowed position.

Instruments and Controls



Instruments and Controls

Controls

Steering Wheel Adjustment

30

Horn

30

Power Outlets

30

Warning Lights, Gauges, and Indicators

Instrument Cluster

32

Speedometer

33

Odometer

33

Trip Odometer

33

Tachometer

33

Fuel Gauge

33

Malfunction Indicator Lamp

Traction Off Light

38

Traction Control System
(TSC) Light

39

Engine Coolant Temperature
Warning Light

Error! Bookmark not defined.

High- Beam On Light

39

Cruise Control Light

39

Climate Control Systems

Climate Control Interface

40

Air Vents

40

Heated Seats

40

Blue Tooth Audio

Introduction

42

29	(Check Engine Light)	Pairing Devices
34	Calibrating Vehicle Speed	42
35	Emissions Inspection and Maintaince Programs	42
36	Brake System Warning Light	
37	Antilock Brake System (ABS) Warning Light	
38		

Controls

Steering Wheel Adjustment



To adjust the steering wheel:

1. Pull the lever down.
2. Move the steering wheel up, down, forward, and backward.
3. Pull the lever up to lock the steering wheel in place.

Do not adjust the steering wheel while driving.

Horn



Press the Steering Wheel Pad to sound the horn

Power Outlet

The accessory power outlets can be used to plug in electrical equipment, such as a cell phone. The vehicle has an accessory power outlet in the accessory tray on the passenger side of dash.

Remove the cover to access and replace when not in use.

! Warning

Power is always supplied to the outlets. Do not leave electrical equipment plugged in when the vehicle is not in use because the vehicle could catch fire and cause injury or death.

Caution
Leaving electrical equipment plugged in for an extended period of time while the vehicle is off will drain the battery. Always unplug electrical equipment when not in use and do not plug in equipment that exceeds the maximum 20 amp rating.

Certain accessory power plugs may not be compatible with the accessory power outlet and could overload vehicle or adapter fuses. If a problem is experienced, contact Vanderhall Service.

When adding electrical equipment, be sure to follow the proper installation instructions included with the equipment.

Warning Lights, Gauges, and Indicators

Warning lights and gauges can signal that something is wrong before it becomes serious enough to cause an expensive repair or replacement. Paying attention to the warning lights and gauges could prevent injury.

Some warning lights come on briefly when the engine is started to indicate they are working. When one of the warning lights comes on and stays on while driving, or when one of the gauges shows there may be a problem, check the section that explains what to do. Waiting to do repairs can be costly and even dangerous.

Instrument Cluster

Speedometer

The speedometer shows the vehicle's speed in miles per hour (mph).

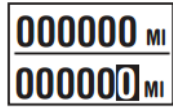

Vehicle Odometer

Trip Odometer

Vehicle Odometer

The odometer shows how far the vehicle has been driven, in miles.

Trip Odometer

The trip odometer shows how far the vehicle has been driven since the trip odometer was last reset.

Press and hold the button on the speedometer to reset the Trip Odometer to zero

Tachometer



The tachometer displays the engine speed in revolutions per minute (rpm).

Fuel Gauge



The fuel gauge indicates about how much fuel is left when the ignition is turned to ON/RUN. When the tank nears empty, the low fuel warning light (1) will come on. There is still a little fuel left, but the vehicle's fuel tank should be filled soon.

The Button (2) can be used to adjust the brightness of the low fuel indicator

Malfunction Indicator Lamp (Check Engine Light)

This light is part of the vehicle's emission control on-board diagnostic system. If this light is on while the engine is running, a malfunction has been detected and the vehicle may require service.

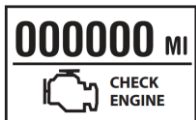

Malfunctions are often indicated by the system before any problem is noticeable. Being aware of the light and seeking service promptly when it comes on may prevent damage

To see the fault code detected momentarily press the button on the speedometer



Holding the button will clear the code from the computer memory, however it will not correct the issue. And the code will come back once the issue is detected by the computer on the next drive cycle

To help prevent damage, reduce vehicle speed and avoid hard accelerations and uphill grades.

Caution

If the vehicle is driven continually with this light on, the emission control system may not work as well, the fuel economy may be lower, and the vehicle may not run smoothly. This could lead to costly repairs.

Caution

Modifications to the engine, transmission, exhaust, intake, or fuel system, or the use of replacement tires that do not meet the original tire specifications, can cause this light to come on. This could lead to costly repairs. This could also affect the vehicle's ability to pass an Emissions Inspection/ Maintenance test.

Check the following:

- A loose or missing fuel cap may cause the light to come on. **SEE FILLING THE TANK ⇨ 65.** A few driving trips with the cap properly installed may turn the light off.
- Poor fuel quality can cause inefficient engine operation and poor drivability, which may go away once the engine is warmed up. If this occurs, change the fuel brand. It may require at least one full tank of the proper fuel to turn the light off. **SEE FUEL ⇨ 65.**

If the light remains on, see your dealer.

Enabling and Disabling Check engine Alert

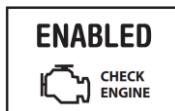

By default the Check Engine Alert is enabled. To access the control menu short press the button the speedometer until the check engine icon is shown

Press and hold the button to toggle between “ENABLED” and “DISABLED”.

ENABLED - Speedometer will show check engine codes and allow you to clear them from the vehicles computer.

DISABLED - Speedometer will not show any check engine codes.

Calibrating Vehicle Speed

The Vehicle speed calibration is performed at the vehicle manufacturing facility. However if recalibration is required because of a significant change in tire size.

Short press the button the speedometer until the Speed Calibration icon is shown.

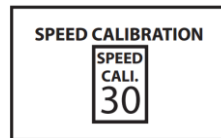

1. Press and hold button for 2-3 seconds to initiate the calibration mode.
2. The LCD screen will prompt you to drive the vehicle to a calibration speed of 30 mph

36

3. Using a known accurate speed device (GPS or similar) drive your vehicle to the calibration speed.

4. When the vehicle reaches the exact calibration speed 30 mph, have a passenger promptly press the button.

5. Calibration is completed. Speedometer will exit calibration automatically and begin displaying the correct speed

Clock



Adjusting the Clock Time

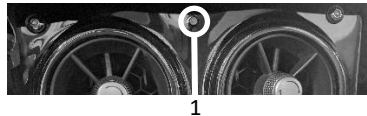

Press and hold the button (1) to rotate clock hands to current time

Emissions Inspection and Maintenance Programs

If the vehicle requires an Emissions Inspection/Maintenance test, the test equipment will likely connect to the vehicle's Data Link Connector (DLC).

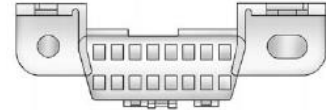

The DLC is under the instrument panel to the right of the steering wheel. Connecting devices that are not used to perform an Emissions Inspection/Maintenance test or to service the vehicle may affect vehicle operation. Contact Vanderhall Service if assistance is needed

The vehicle may not pass inspection if:

- The check engine light is on when the engine is running.
- Critical emission control systems have not been completely diagnosed. If this happens, the vehicle would not be ready for inspection and might require several days of routine driving before the system is ready for inspection. This can happen if the 12-volt battery has recently been replaced or run down, or if the vehicle has been recently serviced.
- Contact Vanderhall Service if the vehicle will not pass or cannot be made ready for the test.

Brake System Warning Light

The vehicle brake system consists of two hydraulic circuits. If one circuit is not working, the remaining circuit can still work to stop the vehicle. For normal braking performance, both circuits need to be working. If the warning light comes on, there is a brake problem. Have the brake system inspected right away.

! Warning

The brake system might not be working properly if the brake system warning light is on. Driving with the brake system warning light on can lead to a crash. If the light is still on after the vehicle has been pulled off the road and carefully stopped, have the vehicle towed for service.

Brake

This light should come on briefly when the ignition is turned to ON. If it does not come on then, have it fixed so it will be ready to warn if there is a problem.

When the ignition is on, the brake system warning light will also come on when the parking brake is set. The light will stay on if the parking brake does not fully release. If it stays on after the parking brake is fully released, it means there is a brake problem.

If the light comes on while driving, carefully pull off the road and stop. The pedal may be harder to push or may go closer to the floor. It may take longer to stop. If the light is still on, have the vehicle towed for service. **SEE TOWING THE VEHICLE**
⇒103

Antilock Brake System (ABS) Warning Light

ABS

This light comes on briefly when the engine is started.

If the light stays on, turn the ignition to LOCK/OFF or if the light comes on, stop as soon as possible and turn the ignition off. Then start the engine again to reset the system. If the light still stays on, or comes on again while driving, the vehicle needs service. Contact Vanderhall Service. If the regular brake system warning light is not on, the brakes will still work, but the antilock brakes will not work. If the regular brake system warning light is also on, the antilock brakes will not work and there is a problem with the regular brakes. **SEE BRAKE SYSTEM WARNING LIGHT ⇒ 37.**

The ABS warning light will come on briefly when the ignition is turned to ON/RUN. This is normal. If the light does not come on then, have it fixed so it will be ready to warn if there is a problem.

Traction off Light

TC

This light comes on briefly while starting the engine. If it does not, have the vehicle serviced by your dealer. If the system is working normally, the indicator light then turns off.

The traction off light comes on when the Traction Control System (TCS) has been turned off by pressing and releasing the TCS/ESC button.

This light and the ESC OFF light come on when ESC is turned off.

If the TCS is off, wheel spin is not limited. Adjust driving accordingly.

SEE TRACTION CONTROL CONTROL ⇒ 61.

Traction Control System (TC) Light

TC

The Traction Control System (TC) indicator/warning light comes on briefly when the engine is started.

If the light does not come on, contact Vanderhall Service. If the system is working normally, the indicator light turns off.

If the light is on and not flashing, the TC, may have been disabled.

If the indicator/warning light is on and flashing, the TCS system is actively working.

SEE TRACTION CONTROL CONTROL ⇨ 61.

High-Beam On Light

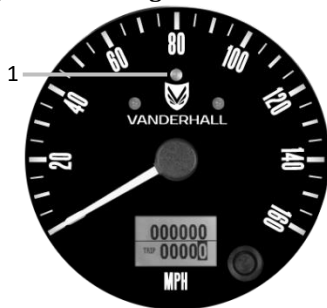

The High-Beam Indicator (1) comes on when the high-beam headlamps are in use. **SEE HEADLAMP HIGH/LOW-BEAM CHANGER ⇨46.**

Cruise Control Light

For vehicles with cruise control, the cruise control light is white when the cruise control is armed, and turns green when the cruise control is set and active.

The light turns off when the cruise control is turned off. **SEE CRUISE CONTROL ⇨ 63.**

Climate Control Systems

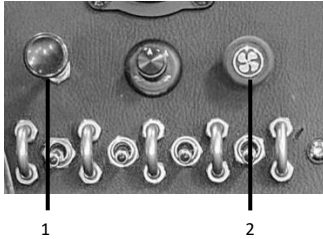

The climate control systems control the heating, cooling, and ventilation for the vehicle.

1. Temperature Control
2. Fan Control

Climate Control Interface

Temperature Control: Push or pull to increase or decrease the temperature.

 **(Fan Control)** : Turn clockwise or counterclockwise to increase or decrease the fan speed.

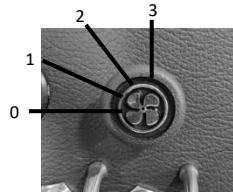

0. Fan Off
1. Low Speed
2. Medium Speed
3. High Speed

Air Vents

Use the air vents located in the center of the dash to direct the airflow. Move the slats on the center air vents to direct airflow. Turn the knobs on the side air vents counterclockwise or clockwise to open or close off the airflow

Heated Seats

The Controls for the heated seats are located on the driver and passenger doorsill

To Turn on the heated seats press the  button. Three lights will appear on the button indicating the heater is on High

Press a second time 2 lights will appear on the button indicating Medium heat

Pressing the button a third time 1 light will be illuminated indicating Low heat

Pressing the button a fourth time will turn the Heated seats off

BluetoothAudio

Introduction

The vehicle is equipped with a Bluetooth® receiver that can be used for playing audio tracks.

! Warning









Taking your eyes off the road for too long or too often while using any radio feature can cause a crash. You or others could be injured or killed. Do not give extended attention to the radio controls or Bluetooth audio devices while driving. Limit your glances at the vehicle displays and focus your attention on driving.

Pairing Devices

1. Turn the Ignition Switch to Accessory or Run
SEE IGNITION POSITIONS ⇨ 54
2. Go to settings on your device. Turn on Bluetooth and search for XUBT3.
3. Select XUBT3 to pair your device
4. Once a device is paired to the vehicle it will automatically reconnect to your device.
5. If there is no device for the vehicle to connect to, it will automatically go into pairing mode to connect with another device.

See your cell phone manufacturer's user guide for Bluetooth functions before pairing the cell phone.

Audio Controls

-  Turn On and Off: Press and hold
-  Play music: Tap knob once
-  Pause music: Tap knob once to pause, tap again to resume playing
-  Skip one track forward: Turn the knob clockwise
-  Skip one track back: Turn the knob counter-clockwise
-  Adjust volume up: Turn and hold the knob clockwise
-  Adjust volume down: Turn and hold the knob counter-clockwise
-  Switch between Bluetooth and auxiliary input: Double tap control knob rapidly to switch between Bluetooth source and AUX input source

Lighting



Lighting

Exterior Lighting

Headlamps	46
Headlamp High/ Low-Beam Changer	46
Momentary High Beams	46
Hazard Warning Flash	46
Turn And Lane Change Signals	48

Lighting Features

Battery Load Management	48
Battery Power Protection	

Exterior Lighting	
Battery Saver	49

Exterior Lighting

Headlamps

The Headlamps are turned on automatically at normal brightness when the vehicle is running.

Headlamp High/ Low-Beam Changer

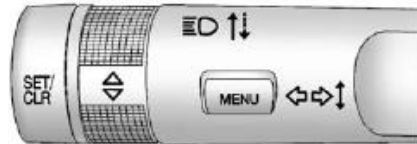

(Headlamp High/Low-Beam

Changer): Push the turn signal lever away from you to turn the high beams on. Push the lever again or pull the lever toward you to return to low beams.

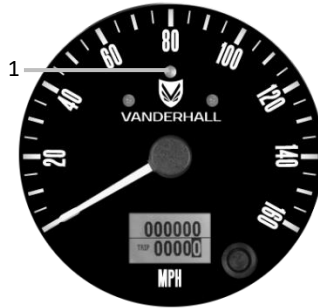

This indicator light turns on in the instrument cluster when the high-beam headlamps are on.

Momentary High Beams/

To momentary activate the high beams; pull the turn signal lever all the way toward you. The release it.

Hazard Warning Flashers

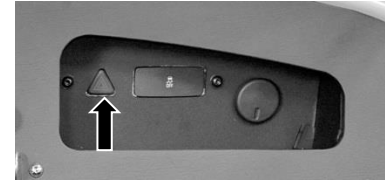

(Hazard Warning Flasher) :

Press and momentarily hold this button to make the front and rear turn signal lamps flash on and off. This warns others that you are having trouble. Press and momentarily hold again to turn the flashers off.

Turn and Lane-Change Signals

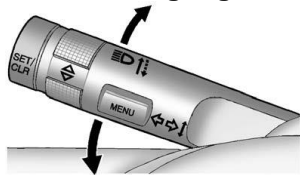

Move the lever all the way up or down to signal a turn.

A light on either side of the Vanderhall Logo in the speedometer will flash in the direction of the turn or lane change.

Raise or lower the lever until the light starts to flash to signal a lane change. Hold it there until the lane change is completed. If the lever is briefly pressed and released, the turn signal flashes three times.

The lever returns to its neutral position when it is released.

If after signaling a turn or lane change the arrow flashes rapidly or does not come on a fuse may have failed. [SEE FUSES AND CIRCUIT BREAKERS ⇨ 88](#)

Turn Signal On Chime

If the turn signal is left on for more than 1.2 km (0.75 mi), a chime will sound at each flash of the turn signal. To turn the chime off, move the turn signal lever to the neutral position.

Lighting Features

Battery Load Management

The vehicle has Electric Power Management (EPM) that estimates the battery's temperature and state of charge. It then adjusts the voltage for best performance and extended life of the battery.

When the battery's state of charge is low, the voltage is raised slightly too quickly bring the charge back up. When the state of charge is high, the voltage is lowered slightly to prevent overcharging.

The battery can be discharged at idle if the electrical loads are very high. This is true for all vehicles. This is because the alternator may not be spinning fast enough at idle to produce all the power needed for very high electrical loads.

A high electrical load occurs when several of the following are on, such as: headlamps, high beams, climate control fan at high speed, heated seats, engine cooling fans, and loads plugged into accessory power outlets.

EPM works to prevent excessive discharge of the battery. It does this by balancing the generator's output and the vehicle's electrical needs. It can increase engine idle speed to generate more power, whenever needed. It can temporarily reduce the power demands of some accessories.

Normally, these actions occur in steps or levels, without being noticeable. In rare cases at the highest levels of corrective action, this action may be noticeable to the driver.

Battery Power Protection

The battery saver feature is designed to protect the vehicle's battery.

Exterior Lighting Battery Saver

The exterior lamps turn off about 10 minutes after the ignition is turned off

To keep the lamps on for more than 10 minutes, the ignition must be in the ACC/ACCESSORY or ON/RUN position.

Driving and operation



52

Driving and Operation

Starting and Operation

New Vehicle Break-In

54

Ignition Positions

54

Starting the Engine

55

Transmission

Automatic Transmission

58

Manual Mode

59

Brakes

Antilock Brake
System (ABS)

60

Parking Brake

60

Vehicle Control Systems

Fuel

Fuel

65

Prohibited Fuels

65

Filling the Tank

65

53

Traction Control

61

Cruise Control

Cruise Control

63

Starting and Operation

New Vehicle Break-In

Caution

The vehicle does not need an elaborate break-in. But it will perform better in the long run if you follow these guidelines:

- Do not drive at a constant speed, fast or slow, for the first 805 km (500 mi). Do not make full-throttle starts.
- Avoid making hard stops for the first 322 km (200 mi) or so. During this time the new brake linings are not yet broken in. Hard stops with new linings can cause premature wear and sooner replacement. This breaking-in guideline should be followed

Ignition Positions

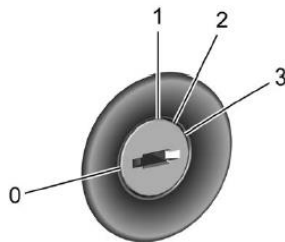

The ignition switch has four different positions.

To shift out of P (Park), the ignition must be in ON/RUN and the brake pedal applied.

0 (STOPPING THE ENGINE/LOCK/ OFF) :

When the vehicle is stopped, turn the ignition switch to LOCK/ OFF to turn the engine off.

Do not turn the engine off when the vehicle is moving. This will cause a loss of power assist in the brake and steering systems

If the vehicle must be shut off in an emergency:

1. Brake using a firm and steady pressure. Do not pump the brakes repeatedly. This may deplete power assist, requiring increased brake pedal force.
2. Shift the vehicle to N (Neutral). This can be done while the vehicle is moving. After shifting to N (Neutral) firmly apply the brakes and steer the vehicle to a safe location.
3. Come to a complete stop. Shift to P (Park). Turn the ignition to LOCK/OFF.
4. Set the parking brake. **SEE PARKING BRAKE ⇨ 60.**

every time you get new brake linings.

If the vehicle cannot be pulled over, and must be shut off while driving, turn the ignition to ACC/ ACCESSORY.

! Warning

Turning off the vehicle while moving may cause loss of power assist in the brake and steering systems. While driving, only shut the vehicle off in an emergency.

Caution

Using a tool to force the key to turn in the ignition could cause damage to the switch or break the key. Use the correct key, make sure it is all the way in, and turn it only with your hand. If the key cannot be turned by hand, see your dealer.

This position locks the ignition, steering wheel and transmission.

1 (ACC/ACCESSORY): This is the position in which things like the radio and the heated seats can be operated when the engine is off.

2 (ON/RUN): This position can be used to operate the electrical accessories and to display some instrument cluster warning and indicator lights. This position can also be used for service and diagnostics, and to verify the proper operation of the malfunction indicator lamp as may be required for emission inspection purposes. The switch stays in this position when the engine is running.

If you leave the key in the ACC/ ACCESSORY or ON/RUN position with the engine off, the battery could be drained. You may not be able to start the vehicle if the battery is allowed to drain for an extended period of time.

3 (START): This is the position that starts the engine. When the engine starts, release the key. The ignition switch returns to ON/RUN for driving.

Starting the Engine

Move the shift lever to P (Park) or N (Neutral). To restart the engine when the vehicle is already moving, use N (Neutral) only.

Caution

Do not try to shift to P (Park) if the vehicle is moving. If you do, you could damage the transmission. Shift to P (Park) only when the vehicle is stopped.

Retained Accessory Power (RAP)

These vehicle accessories may be used for up to 10 minutes after the engine is turned off:

- . Heated Seats
- . Power Outlet

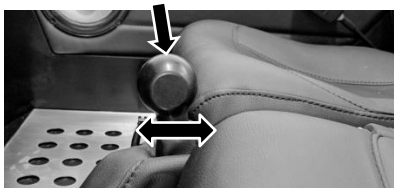
Shifting out of Park

This vehicle is equipped with a shift lock control. The shift lock control is designed to; Prevent movement of the shift lever out of P (Park) unless the ignition is in ON/RUN and the brake pedal is applied.

The shift lock control is always functional except in the case of an uncharged or low voltage (less than 9-volt) battery. If the vehicle has an uncharged battery or a battery with low voltage, try charging or jump starting the battery.

To shift out of P (Park):

1. Apply the brake pedal.
2. Turn the ignition to ON/RUN.
3. Press down on the shift lever
4. Move the shift lever to the desired position.

Shifting Into Park

1. Hold the brake pedal down and set the parking brake. SEE **PARKING BRAKE ⇄ 60.**
2. Move the shift lever into P (Park) by pressing down on the shift lever and pushing the lever all the way toward the front of the vehicle.
3. Turn the ignition key to LOCK/OFF.

Remove the key and take it with you.

Torque Lock

If you are parking on a hill and you do not shift the transmission into P (Park) properly, the weight of the vehicle may put too much force on the parking pawl in the transmission. You may find it difficult to pull the shift lever out of P (Park). This is called “torque lock.” To prevent torque lock, set the parking brake and then shift into P (Park) properly before you leave the driver seat. To find out how, see “Shifting Into Park” previously in this section.

When you are ready to drive, move the shift lever out of P (Park) before you release the parking brake.

If torque lock does occur, you may need to push the vehicle a little uphill to take some of the pressure from the parking pawl in the transmission, so you can pull the shift lever out of P (Park).

Transmission

Automatic Transmission



Your Vanderhall Venice is equipped with an automatic transmission.

P (Park): In Park the front wheels are locked. Use this position when starting the engine or exiting the vehicle, because it will prevent the vehicle from moving.

The vehicle has a shift lock out. You must fully apply the brake pedal then press the shift lever down before you can move from P (Park) while the ignition key is in ON/RUN.

! Warning

It is dangerous to get out of the vehicle if the shift lever is not fully in P (Park) and the parking brake firmly set. As the vehicle could roll.

Do not leave the vehicle when the engine is running. The vehicle could move suddenly, injuring you or others.

To be sure the vehicle will not move always set the parking brake and move the shift lever to P (Park).

R (Reverse): Use this gear to back up.

Caution

Shifting to R (Reverse) while the vehicle is moving forward could damage the transmission. Shift to R (Reverse) only after the vehicle is stopped.

N (Neutral): In this position, the engine is isolated from the front wheels. To restart the engine when the vehicle is already moving, use N (Neutral) only.

Use N (Neutral) if the vehicle is being towed.

D (Drive) : This position is for normal driving.

M (Manual Mode): This is an optional position that if equipped allows you to change gears similar to a manual transmission

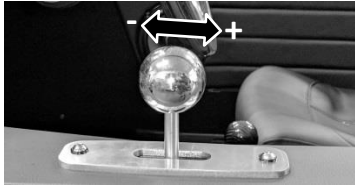

Manual Mode

To use this feature:

1. Move the shift lever from D (Drive) rearward to M (Manual). While driving in manual mode, the transmission will remain in the driver selected gear. When coming to a stop, the vehicle will automatically shift into 1 (First) gear.
2. Pull the Bump Shifter towards you to up shift

3. Push the Bump Shifter away from you to down shift

While using manual mode, the transmission will have firmer shifting and sportier performance. This setting can be used for sport driving.

The transmission will only allow you to shift into gears appropriate for the current vehicle speed and engine revolutions per minute (rpm):

- The transmission will not automatically shift to the next higher gear if the vehicle speed or engine rpm is too low.
- The transmission will not allow shifting to the next lower gear if the vehicle speed or engine rpm is too high.

Brakes

Antilock Brake System (ABS)

This vehicle has ABS, a system that helps prevent a braking skid.

When the vehicle begins to drive, the ABS will perform a self-check. A momentary motor or clicking noise might be heard during the test, and it might even be noticed that the brake pedal moves a little. This is normal.



If there is a problem with ABS, this warning light stays on. **SEE ANTILOCK BRAKE SYSTEM (ABS) WARNING LIGHT ⇨38.**

The ABS system monitors wheel speed and braking pressure at each wheel. If while braking the system senses a wheel is about to stop rolling the computer will work each brake, while the driver maintains braking pressure

ABS can change the brake pressure to each wheel, as required, faster than any driver could. This can help you steer around the obstacles while braking hard.

Remember: ABS does not change the time needed to get a foot up to the brake pedal or always decrease stopping distance. If you get too close to the vehicle in front of you, there will not be enough time to apply the brakes if that vehicle suddenly slows or stops. Always leave enough room up ahead to stop, even with ABS.

Using ABS

Do not pump the brakes. Just hold the brake pedal down firmly and let ABS work. You may hear the ABS pump or motor operating and feel the brake pedal pulsate. This is normal.

Braking in Emergencies

ABS allows you to steer and brake at the same time. In many emergencies, steering can help more than even the very best braking.

Parking Brake

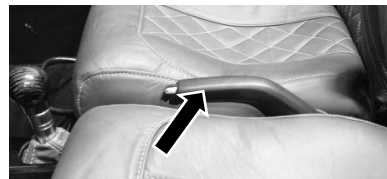

To set the parking brake, hold the brake pedal down and pull up on the parking brake lever. If the ignition is on, the brake system warning light will come on. SEE **BRAKE SYSTEM WARNING LIGHT 37**

To release the parking brake, hold the brake pedal down. Pull the parking brake lever up until you can press the release button. Hold the release button in as you move the brake lever all the way down.

Caution

Driving with the parking brake on can overheat the brake system and cause premature wear or damage to brake system parts. Make sure that the parking brake is fully released and the brake warning light is off before driving.

Vehicle Control Systems

Traction Control

System Operation

The vehicle has a Traction Control System (TCS) which is designed to limit wheel slip. TCS activates if it senses that any of the drive wheels are spinning or beginning to lose traction. When this happens, TCS applies the brakes to the spinning wheels and reduces engine power to limit wheel spin.

If cruise control is being used and the TCS becomes active, the cruise control system will disengage. Cruise control may be turned back on when road conditions allow.

The TCS systems come on automatically when the vehicle is started and begins to move. The systems may be heard or felt

This is normal and does not mean there is a problem with the vehicle.

Turning the System Off and On

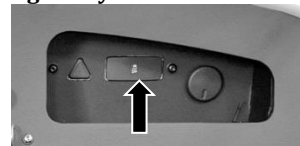

The TSC button is located on the passenger side of the dash

To turn off TCS, press and release the  button. The traction off light **TC** displays in the instrument cluster.

To turn TCS on again, press and release the  button. The traction off light **TC** displayed in the instrument cluster will turn off.

If TCS is limiting wheel spin when the  button is pressed, the system will not turn off until the wheels stop spinning.

while they are operating or while performing diagnostic checks.

Cruise Control

If this vehicle is equipped with a cruise control system. The system will allow the vehicle to maintain a speed of about 25MPH (40 km/h) or more. Without the driver keeping their foot on the accelerator pedal.

If the vehicles Traction Control System (TSC) begins limiting wheel slip the cruise control will disengage.

If the brakes are applied, the cruise control system will disengage.

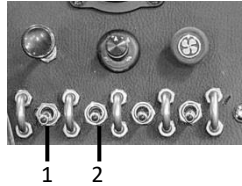

- 1 Cruise Control Activation
- 2 Cruise Control Speed Adjust

Cruise Control Activation: Flip the switch to the up position to activate Cruise Control. Return the switch to the down position to deactivate Cruise Control

Cruise Control Speed Adjust Up Position (Resume/Accelerate) :: If there is a set speed in memory, move the switch up briefly to resume to that speed or hold upward to accelerate. If cruise control is already active, use to increase vehicle speed.

Cruise Control Speed Adjust Down

Position, (Set/Coast): Move the switch down briefly to set the speed and activate cruise control. If cruise control is already active, use to decrease speed.

Setting Cruise Control:

To set cruise control:

1. Rotate Switch one up to turn the cruise system on.
2. Bring the vehicle to the speed desired.
3. Press Switch 2 down and release it to set the speed.
4. Take your foot off the accelerator pedal.

Resuming a Set Speed

If the cruise control is set at a desired speed and then the brakes are applied or TSC detected a slip condition, the cruise control is disengaged without erasing the set speed from memory

Once the vehicle reaches about 25 mph (40 km/h) or more, move the thumbwheel up toward RES/+ briefly. The vehicle returns to the previous set speed.

Increasing Speed While Using Cruise Control

If the cruise control system is already activated:

- Push the Cruise Control Speed Adjust Switch upward and hold it until the desired speed is reached, then release the switch.

- To increase the vehicle speed in small increments, move the Cruise Control Speed Adjust Switch upward briefly and then release it. For each press, the vehicle goes about 1 mph faster.

Reducing Speed While Using Cruise Control

If the cruise control system is already activated:

- Press the Cruise Control Speed Adjust Switch downward and hold it until the desired lower speed is reached, then release the switch.
- To decrease the vehicle speed in smaller increments, move the Cruise Control Speed Adjust Switch downward briefly and then release it. For each press, the vehicle goes about 1 mph slower.

Pressing the Accelerator while using Cruise Control

Use the accelerator pedal to increase the vehicle speed. When you take your foot off the pedal, the vehicle will slow down to the previous set cruise control speed.

To override cruise control, briefly moving the Cruise Control Speed Adjust Switch downward will set the cruise control to the current vehicle speed.

Fuel

Use of the recommended fuel is an important part of the proper maintenance of this vehicle. Use regular unleaded gasoline with a posted octane rating of 91 or higher. Do not use gasoline with an octane rating below 91, as it may cause engine damage and will lower fuel economy

Prohibited Fuels

Gasolines containing oxygenates such as ethers and ethanol, as well as reformulated gasolines, are available in some cities. If these gasolines comply with the previously described specification, then they are acceptable to use. However, E85 (85% ethanol) and other fuels containing more than 15% ethanol must not be used in this vehicle

Caution

Do not use fuel containing methanol. It can corrode metal parts in the fuel system and also damage plastic and rubber parts.

Some gasolines, mainly high octane racing gasolines, can contain an octane-enhancing additive called methylcyclopentadienyl manganese tricarbonyl (MMT). Do not use gasolines and/or fuel additives with MMT as they can reduce spark plug life and affect emission control system performance. The malfunction indicator lamp may turn on. If this occurs, contact Vanderhall Service.

Filling the Tank**! Warning**

Fuel vapors and fuel fires burn violently and can cause injury or death.

- To help avoid injuries to you and others, read and follow all the instructions on the fuel pump island.
- Turn off the engine when refueling.
- Keep sparks, flames, and smoking materials away from fuel.
- Do not leave the fuel pump unattended.
- Do not use a cell phone while refueling.
- Do not reenter the vehicle while pumping fuel.
- Keep children away from the fuel pump and never let children pump fuel.

! Warning (Continued)

- Fuel can spray out if the fuel cap is opened too quickly. This spray can happen if the tank is nearly full, and is more likely in hot weather. Open the fuel cap slowly and wait for any hiss noise to stop then unscrew the cap all the way.



The Fuel fill is located in the tail of the vehicle,

To remove the fuel cap, turn it slowly counterclockwise. The fuel cap has a spring in it; if the cap is released too soon, it will spring back to the right.

When filling the vehicle keep the flow from the fuel nozzle slow. Typically squeezing the lever halfway works best to prevent overflow

Do not use the automatic fuel flow shutoff feature on many nozzles, as this can lead to fuel spillage

Be careful not to spill fuel. Do not top off or overfill the tank. Wait a few seconds after you have finished pumping before removing the nozzle.

! Warning

Overfilling the fuel tank may cause:

- Vehicle performance issues, including engine stalling and damage to the fuel system.
- Fuel spills.
- Potential fuel fires

Clean fuel from painted surfaces as soon as possible. **SEE "WASHING THE VEHICLE" IN EXTERIOR CARE ⇨98.**

When replacing the fuel cap, turn it clockwise until it clicks. Ensure the cap is fully installed. The diagnostic system can determine if the fuel cap has been left off or improperly installed. Allowing fuel to evaporate into the atmosphere. **SEE MALFUNCTION INDICATOR LAMP (CHECK ENGINE LIGHT) ⇨34.**

Vehicle Care



Vehicle Care

General Information

California Proposition
65 Warning

71

California Perchlorate
Materials Requirement

71

Accessories and
Modifications

71

Vehicle Checks

Hood

71

Engine Compartment
Overview

72

Engine Oil

74

Automatic Transmission

Brakes

82

Brake Fluid

83

Battery

86

Vehicle Storage

87

Exterior Lighting

Headlight Aiming

87

Bulb Replacement

87

Electrical System

Electrical System Overload

88

Fuses and Circuit Breakers

88

Engine Compartment

90

Fuse Block

100

Instrument Panel

92

Fuse Block

92

Wheels and Tires

Tires

93

Tire Pressure

94

Tire Inspection

95

Buying New Tires

95

Jump Starting

Jump Starting

96

Appearance Care

Exterior Care

98

Interior Care

100

Towing the Vehicle

Towing the Vehicle

103

70

Fluid

77

Engine Air Filter

77

Engine Coolant

77

Engine Overheating

80

General Information

For service and parts contact Vanderhall service for the highest quality replacement parts.

California Proposition 65 Warning

WARNING: Most motor vehicles, including this one, contain and/or emit chemicals known to the State of California to cause cancer and birth defects or other reproductive harm. Engine exhaust, many parts and systems, many fluids, and some component wear by-products contain and/or emit these chemicals.

California Perchlorate Materials Requirements

Certain types of automotive Applications such as lithium batteries contained in Remote Keyless Entry transmitters, may contain perchlorate materials. Special handling may be necessary. For additional information, see www.dtsc.ca.gov/hazardouswaste/perchlorate

Accessories and Modifications

Adding non-dealer accessories or making modifications to the vehicle can affect vehicle performance and safety, including such things as braking, stability, ride and handling, emissions systems, aerodynamics, durability, and electronic systems like antilock brakes, traction control, and stability control. These accessories or modifications could even cause malfunction or damage

Vehicle Checks

Hood



To remove the hood:

- Remove the 8 bolts from the perimeter of the hood
- Lift the hood off the vehicle

Engine Compartment Overview

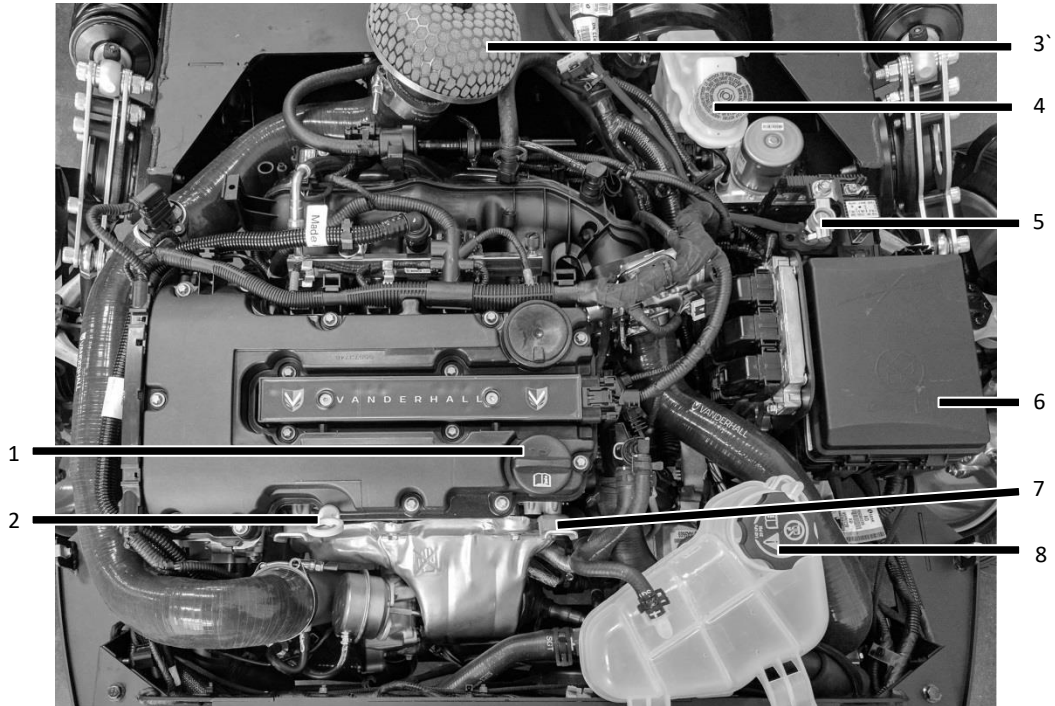

1. Engine Oil Fill Cap
2. Engine Oil Dipstick
3. Engine Air Filter
4. Brake Fluid Reservoir
5. Positive Jump Start Post
6. Fuse box
7. Negative Jump start Post
8. Engine Coolant Surge Tank and Pressure Cap

Engine Oil

To ensure proper engine performance and long life, careful attention must be paid to engine oil. Following these simple, but important steps will help protect your investment:

- Always use engine oil approved to the proper specification and of the proper viscosity grade. See “Selecting the Right Engine Oil” in this section.
- Check the engine oil level regularly and maintain the proper oil level. See “Checking Engine Oil” and “When to Add Engine Oil” in this section.
- Change the engine oil at the appropriate time.
- Always dispose of engine oil properly. See “What to Do with Used Oil” in this section

Checking Engine Oil

It is a good idea to check the engine oil level monthly when the vehicle is in usage. In order to get an accurate reading, the oil must be warm and the vehicle must be on level ground. The engine oil dipstick handle is a loop. **SEE ENGINE COMPARTMENT OVERVIEW ⇨ 72** for the location of the engine oil dipstick.

1. If the engine has been running recently, turn off the engine and allow several minutes for the oil to drain back into the oil pan. Checking the oil level too soon after engine shutoff will not provide an accurate oil level reading.

! Warning

The engine oil dipstick handle may be hot; it could burn you. Use a towel or glove to touch the dipstick handle.

2. Pull out the dipstick and wipe it with a clean paper towel or cloth, then push it back in all the way. Remove it again, keeping the tip down, and check the level.

When to Add Engine Oil



If the oil is below the minimum mark on the dipstick, add 1 qt (1 L) of the recommended oil and then recheck the level. See “Selecting the Right Engine Oil” in this section for an explanation of what kind of oil to use. For engine oil crankcase capacity, [SEE CAPACITIES AND SPECIFICATIONS ⇒ 112.](#)

[SEE ENGINE COMPARTMENT OVERVIEW ⇒ 72](#) for the location of the engine oil fill cap.

Add enough oil to put the level somewhere in the proper operating range. Push the dipstick all the way back in when through.

Caution

Do not add too much oil. Oil levels above or below the acceptable operating range shown on the dipstick are harmful to the engine. If you find that you have an oil level above the operating range, i.e., the engine has so much oil that the oil level gets above the upper mark that shows the proper operating range, the engine could be damaged. You should drain out the excess oil or limit driving of the vehicle and seek a service professional to remove the excess amount of oil.

Selecting the Right Engine Oil

Selecting the Right Engine oil depends on getting the correct viscosity grade. [SEE RECOMMENDED FLUIDS AND LUBRICANTS ⇒ 110.](#)

Viscosity Grade

Use SAE 5W-30 viscosity grade engine oil.

Engine Oil Additives/Engine Oil Flushes

Do not add anything to the oil. Engine oil system flushes are not recommended and could cause engine damage.

When to Change Engine Oil

The engine oil and filter must be changed at least once a year and, Your dealer has trained service people who will perform this work. It is also important to check the oil regularly over the course of an oil drain interval and keep it at the proper level.

If the system is ever reset accidentally, the oil must be changed at 3,000 mi (5 000 km) since the last oil change.

Automatic Transmission Fluid

How to Check Automatic Transmission Fluid

It is not necessary to check the transmission fluid level. A transmission fluid leak is the only reason for fluid loss. If a leak occurs, contact Vanderhall Service as soon as possible.

There is a special procedure for checking and changing the transmission fluid. Because this procedure is difficult, you should have this done by a professional. Change the fluid at the intervals listed in [MAINTENANCE SCHEDULE ⇨ 106](#), and be sure to use the fluid listed in [RECOMMENDED FLUIDS AND LUBRICANTS ⇨ 110](#).

Engine Air Filter

The engine air filter is located at the center rear of the engine compartment. [SEE ENGINE COMPARTMENT OVERVIEW ⇨ 72](#)

When to Inspect the Engine Air Cleaner/Filter

For intervals on changing and inspecting the engine air filter, [SEE MAINTENANCE SCHEDULE ⇨ 106](#)

How to Inspect the Engine Air Filter

Do not start the engine or have the engine running without the engine air filter. Remove the engine air filter. Lightly tap and shake the engine air filter (away from the vehicle), to release loose dust and dirt. Inspect the engine air filter for damage, replace if damage is found. Replace if dust and dirt is not easily removed.

Engine Coolant

The cooling system in the vehicle is filled with DEX-COOL engine coolant. This coolant is designed to remain in the vehicle for 5 years or 150,000 mi (240 000 km), whichever occurs first.

The following explains the cooling system and how to check and add coolant when it is low. If there is a problem with engine overheating, [SEE ENGINE OVERHEATING ⇨ ERROR! BOOKMARK NOT DEFINED..](#)

Use a 50/50 mixture of clean drinkable water and DEX-COOL coolant. This mixture:

- Gives freezing protection down to -34 °F (-37 °C), outside temperature.
- Gives boiling protection up to 265 °F (129 °C), engine temperature.
- Protects against rust and corrosion.

Will not damage aluminum parts.

- Helps keep the proper engine temperature.

! Warning

Adding only plain water or some other liquid to the cooling system can be dangerous. Plain water and other liquids, can boil before the proper coolant mixture will. The coolant warning system is set for the proper coolant mixture. With plain water or the wrong mixture, the engine could get too hot but you would not get the overheat warning. The engine could catch fire and you or others could be burned. Use a 50/ 50 mixture of clean, drinkable water and DEX-COOL coolant.

Caution

If improper coolant mixture, inhibitors, or additives are used in the vehicle cooling system, the engine could overheat and be damaged. Too much water in the mixture can freeze and crack engine cooling parts. Use only the proper mixture of engine coolant for the cooling system. **SEE RECOMMENDED FLUIDS AND LUBRICANTS ⇨ 110.**

Checking Coolant

The vehicle must be on a level surface when checking the coolant level

It is normal to see coolant moving in the upper coolant hose return line when the engine is running.

If the engine has been recently running even for a short time. The coolant in the cooling system could be very hot and under

pressure. Allow the engine to cool completely before attempting to open the surge tank

If coolant is visible but the coolant level is not at or above the mark pointed to, add a 50/50 mixture of clean drinkable water and DEX-COOL coolant.

If no coolant is visible in the coolant surge tank, add coolant as follows:

How to Add Coolant to the Coolant Surge Tank

Caution

This vehicle has a specific coolant fill procedure. Failure to follow this procedure could cause the engine to overheat and be severely damaged.

If no coolant is visible in the coolant surge tank, or it is visible but the level is not at the indicated level mark. Add a 50/ 50 mixture of clean, drinkable water and DEX-COOL coolant to the coolant surge tank. Before attempting to open the surge tank be sure the cooling system, including the coolant surge tank pressure cap, is cool to the touch.

! Warning

You could be badly burned by steam and scalding liquids blowing out of the system. Never turn the cap when the cooling system, including the surge tank pressure cap, is hot. Wait for the cooling system and surge tank pressure cap to cool before doing any work.

Coolant contains ethylene glycol and it can burn if spilled on hot engine parts. Do not allow coolant to spill on hot

! Warning

Adding only plain water or some other liquid to the cooling system can be dangerous. Plain water and other liquids, can boil before the proper coolant mixture will. The coolant warning system is set for the proper coolant mixture. With plain water or the wrong mixture, the engine could get too hot but you would not get the overheat warning. The engine could catch fire and you or others could be burned. Use a 50/ 50 mixture of clean, drinkable water and DEX-COOL coolant.

Caution

In cold weather, water in the cooling system can freeze and crack the engine, and cooling system parts. Use the recommended coolant and the proper coolant mixture, even when the vehicle is in storage.



1. When the cooling system is cool to the touch Remove the coolant surge tank pressure cap.
2. Turn the pressure cap counterclockwise slowly about one-quarter of a turn. If you hear a hiss, wait for the hiss to stop. This will allow any pressure in the system be vented out the discharge hose.
3. Fill the coolant surge tank to the indicated level mark with the proper DEX-COOL coolant mixture.

engine parts you could be badly burned.



1. With the coolant surge tank pressure cap off, start the engine and let it run until you can feel the upper radiator hose getting hot. Keep your hands clear of the engine cooling fan.
2. The coolant level inside the coolant surge tank may drop below the level mark while the engine is running. If the level does drop, add more of the proper DEX-COOL coolant

mixture to the coolant surge tank until the level reaches the indicated level mark.

3. Replace the pressure cap tightly.
4. Check the level in the coolant surge tank when the cooling system has cooled down. If the coolant is not at the proper level, repeat Steps 1–3 and reinstall the pressure cap. If the coolant still is not at the proper level when the system cools down again, contact Vanderhall Service.

Caution

Ensure the pressure cap is fully tightened. If it is not coolant loss and engine damage may occur.

Engine Overheating

If Steam Is Coming from the Engine Compartment

! Warning

Steam from an overheated engine can burn you badly, even if you just open the hood. Stay away from the engine if you see or hear steam coming from it. Just turn it off and get everyone away from the vehicle until it cools down. Wait until there is no sign of steam or coolant before you open the hood.

If you keep driving when the engine is overheated, the liquids in it can catch fire. You or others could be badly burned. Stop the engine if it overheats, and get out of the vehicle until the engine is cool.

If No Steam Is Coming from the Engine Compartment

Sometimes the engine can overheat when the vehicle:

- Climbs a long hill on a hot day.
- Stops after high-speed driving.

If the vehicle begins to overheat:

1. Turn the air conditioning off.
2. Turn the heater on to the highest temperature and to the highest fan speed.
3. When it is safe to do so, pull off the road, shift to P (Park) and let the engine idle for about 3 minutes.

If the overheat warning is no longer present, the vehicle can be driven. However drive the vehicle gently for about 10 minutes. If the warning does not come back on, the vehicle can be driven normally. Have the cooling system checked for proper fill and function.

If the warning is still displayed, turn off the engine and wait for it to cool down.

If the warning continues, pull over, stop, and park the vehicle right away.

Brakes

Disc brake pads have built-in wear indicators that make a high-pitched warning sound when the brake pads need to be replaced. The sound can come and go or it maybe heard all the time when the vehicle is moving.

! Warning

The brake wear warning sound means that soon the brakes will not work well. When the brake wear warning sound is heard, have the vehicle serviced.

Failure to replace the brake pads could lead to a crash or costly brake system repairs.

Some driving conditions or climates can cause a brake squeal when the brakes are first applied or lightly applied. This may be noticed the first few stops after storing the vehicle. This does not mean something is wrong with the brakes.

Brake Pedal Travel

The following conditions could indicate brake service is required. Contact Vanderhall Service if:

- The brake pedal does not return to normal height
- There is a rapid increase in pedal travel
- The pedal lacks firmness.

Replacing Brake System Parts

The brakes may not work properly, or with the same performance if unapproved parts are used or parts are improperly installed.

Always replace brake system parts with new, approved replacement parts. And ensure the work is done by qualified mechanics.

Brake Fluid



The brake master cylinder reservoir is filled with DOT 3 brake fluid as indicated on the reservoir cap. **SEE ENGINE COMPARTMENT OVERVIEW ⇒ 72** for the location of the reservoir.

- Normal brake pad wear. This will be corrected when new pads are installed, and is not an indication that the system needs repair.
- A fluid leak in the brake hydraulic system. Have the brake hydraulic system repaired. With a leak in the system the brakes will not perform well.

Always clean the brake fluid reservoir cap and the area around the cap before removing it.

Do not top off the brake fluid. If fluid is added when the pads are worn, there will be too much fluid when new brake pads are installed.

! Warning

If too much brake fluid is added, it may spill on the engine and burn, if the engine is hot enough. Potentially burning you or other and damaging the vehicle. Brake fluid should only be added when work is done on the brake hydraulic system.

There are only two reasons why the brake fluid level in the reservoir might be low: When the brake fluid falls to a low level, the brake warning light will come on. SEE **BRAKE SYSTEM WARNING LIGHT** ⇨ 37.

Brake fluid absorbs water over time. Replace brake fluid at the specified intervals to maintain optimal brake performance. SEE **MAINTENANCE SCHEDULE** ⇨ 106.

What to Add

Use only DOT 3 brake fluid from a clean, sealed container. SEE **RECOMMENDED FLUIDS AND LUBRICANTS** ⇨ 110.

Caution
Brake fluid will damage painted surfaces. Immediately wash any area that brake fluid is spilled on.

! Warning
Using the wrong or contaminated brake fluid could result in damage to the brake system. This could lead to the loss of braking and possible injury. Always use the proper brake fluid from a clean sealed container, and clean the

85

cap and area around the brake resivor
before opening.

Battery



The battery is located in its own compartment. This compartment can be accessed by:

- Sliding the passenger seat all the way forward.
- Removing the battery compartment door there are 4 wingnuts securing the door.

The original equipment battery is maintenance free. Do not remove the cap and do not add fluid.

Refer to the replacement number shown on the original battery label when a new battery is needed.

! Warning

WARNING: Battery posts, terminals, and related accessories contain lead and lead compounds, chemicals known to the State of California to cause cancer and birth defects or other reproductive harm. Batteries also contain other chemicals known to the State of California to cause cancer.

WASH HANDS AFTER HANDLING. SEE CALIFORNIA PROPOSITION 65 WARNING 71

! Warning

Batteries have acid that can burn you and gas that can explode. You can be badly hurt if you are not careful. SEE JUMP STARTING - 96 FOR tips on working around a battery without getting hurt.

Vehicle Storage

When the vehicle is going to be stored for an extended period of time it is important to disconnect the battery or use a trickle charger to prevent the battery from discharging

To disconnect the battery, remove the battery compartment door see Battery in this section. Disconnect the negative (-) battery cable

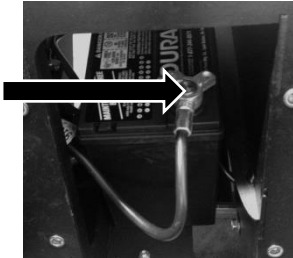

Exterior Lighting

Headlamp Aiming

Headlamp aim has been preset and should need no further adjustment. If the vehicle is damaged in a crash, the headlamp aim may be affected. If adjustment to the headlamps is necessary, contact Vanderhall Service

Bulb Replacement

The vehicles exterior lamps including headlight, turn signals, and license plate are LED and are not serviceable. Should a lamp fail contact Vanderhall Service for a replacement

Electrical System

Electrical System Overload

The vehicle has fuses and circuit breakers to protect against an electrical system overload.

When the current electrical load is too heavy, the circuit breaker opens and closes, protecting the circuit until the current load returns to normal or the problem is fixed. This greatly reduces the chance of circuit overload and fire caused by electrical problems.

Fuses and circuit breakers protect power devices in the vehicle.

Replace a bad fuse with a new one of the identical size and rating.

fuse can be borrowed. Choose some feature of the vehicle that is not needed to use and replace it as soon as possible.

Headlamp Wiring

An electrical overload may cause the lamps to go on and off, or in some cases to remain off. Have the headlamp wiring checked right away if the lamps go on and off or remain off.

Fuses and Circuit Breakers

The wiring circuits in the vehicle are protected from short circuits by a combination of fuses, circuit breakers, and fusible thermal links. This greatly reduces the chance of fires caused by electrical problems.

Look at the silver-colored band inside the fuse. If the band is broken or melted, replace the fuse. Be sure you replace a bad fuse with a new one of the identical size and rating.

Fuses of the same amperage can be temporarily borrowed from another fuse location, if a fuse goes out. Replace the fuse as soon as you can.

89

If there is a problem on the road and a fuse needs to be replaced, the same amperage

Engine Compartment Fuse Block



The engine compartment fuse block is on the driver side of the vehicle under the hood.

Caution

Liquid on any vehicle electrical component may damage it. Always keep the covers on electrical components.

To access the fuses, press the clips together, and lift the cover. To reinstall the cover, push the cover until it is secure.

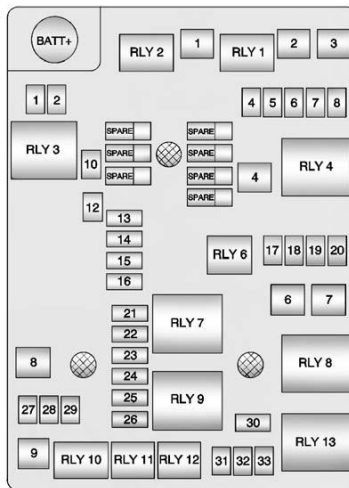

Mini Fuses	Usage
1	Antilock Brake System Valve
2	Not Used
4	Not Used
5	Regulated Voltage Control
6	Antilock Brake System Fluid
7	Not Used
8	Not Used
10	Not Used
12	Not Used
13	Heated Seats
14	Fuel System Control Module 1
15	Flex Fuel
16	Not Used
17	Fuel Pump
18	Engine Control Module 5
19	Fuel System Control Module 2
20	Transmission Control Module 1

Mini Fuses	Usage
21	Engine Control Module 1
22	Coil
23	Engine Control Module 4
24	Engine Control Module 3
25	Engine Control Module 2
26	Injector/Ignition Coil
27	Engine Control Module
28	Not Used
29	Transmission Control Module
30	Horn
31	Not Used
32	Left High Beam
33	Right High Beam
Spare	Spare

J-Case Fuses	Usage
1	Antilock Brake System Pump
2	Not Used
3	Blower
4	Run/Crank IEC
6	Cooling Fan K5
7	Cooling Fan K4
8	EVP
9	Start

Relay	Usage
RLY 1	Not Used
RLY 2	Not Used
RLY 3	Not Used
RLY 4	Run/Crank Relay
RLY 6	Fuel Pump Relay
RLY 7	Cooling Fan K2 Relay
RLY 8	Cooling Fan K3 High Current Relay
RLY 9	Powertrain Relay
RLY 10	Start High Current Relay
RLY 11	Not Used
RLY 12	High-Beam Relay
RLY 13	Cooling Fan K1 Relay

Instrument Panel Fuse Block

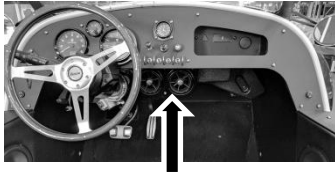

The instrument Panel Fuse Block is located under the dash against the firewall

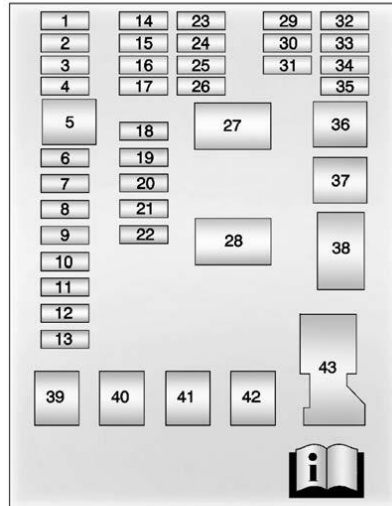

Number	Usage
1	DLIS
2	Data Link Connector
3	Not Used
4	Not Used
5	Spare
6	Body Control Module 8
7	Body Control Module 7
8	Body Control Module 6
9	Body Control Module 5
10	Body Control Module 4
11	Body Control Module 3
12	Body Control Module 2
13	Body Control Module 1
14	Instrument Cluster
15	Not Used
16	Not Used
17	Not Used
18	Audio
19	Not Used
20	Not Used

Number	Usage
21	Not Used
22	Heating,
23	HDLP ALC
24	Not Used
25	Instrument Cluster
26	Run/Crank
27	Run Relay
28	Not Used
29	Not Used
30	Horn clock Spring
31	Heating,
32	Spare
33	Not Used
34	Accessory Power
35	Spare
36	Not Used
37	Not Used
38	RAP/ACCY
39	Not Used
40	Not Used

Number	Usage
41	PTC2
42	PTC1
33	Battery connector

Wheels and Tires

Tires

This vehicle comes with high performance tires, with a tread and compound that are optimized for dry and wet road performance. While offering high speed handling and a comfortable ride. For additional information refer to the tire manufacturer.

! Warning

Poorly maintained and improperly used tires are dangerous.

(Continued)

! Warning

- Underinflated tires pose a danger and could result in a crash causing serious injury. Check all tires frequently to maintain the recommended pressure. Tire pressure should be checked when the tires are cold.
- Overinflated tires are more likely to be cut, punctured, or broken by a sudden impact — such as when hitting a pothole. Keep tires at the recommended pressure.
- Worn or old tires can cause a crash. If the tread is badly worn, replace them.
- Replace any tires that have been damaged by impacts with potholes, curbs, etc.
- Improperly repaired tires can cause a crash. Only the dealer or an authorized tire service center should repair, replace, dismount, and mount the tires.

Recommended Inflation Pressure:

The recommended tire inflation pressure is shown on the tire placard see Tire Pressure in this section.

Tire Pressure

Tires need the correct amount of air pressure to operate effectively.

Caution
<p>Neither tire under inflation nor over inflation is good. Underinflated tires, or tires that do not have enough air, can result in:</p> <ul style="list-style-type: none"> • Tire overloading and overheating which could lead to a blowout. • Premature or irregular wear. • Poor handling. • Reduced fuel economy. <p>Overinflated tires, or tires that have too much air, can result in:</p> <p style="text-align: right;">(Continued)</p>

Caution
<ul style="list-style-type: none"> • Unusual wear. • Poor handling. • Rough ride. <p style="text-align: center;">Needless damage from road hazards.</p>

The Tire and Loading Information label on the vehicle indicates the original equipment tires and the correct cold tire inflation pressures. The recommended pressure will give the best vehicle handling and ride comfort

The Tire Pressure Placard can be found under the dash on the driver side of the vehicle

When to Check

Check the tires once a month or more.

How to Check

Use a good quality pocket-type gauge to check tire pressure. Proper tire inflation cannot be determined by looking at the tire. Check the tire inflation pressure when

the tires are cold, meaning the vehicle has not been driven for at least three hours or no more than 1.6 km (1 mi).

Remove the valve cap from the tire valve stem. Press the tire gauge firmly onto the valve to get a pressure measurement. If the cold tire inflation pressure matches the recommended pressure on the Tire and Loading Information label, no further adjustment is necessary. If the inflation pressure is low, add air until the recommended pressure is reached. If the inflation pressure is high, press on the metal stem in the center of the tire valve to release air.

Recheck the tire pressure with the tire gauge. Put the valve caps back on the valve stems to keep out dirt and moisture and prevent leaks.

Tire Inspection

We recommend that the tires be inspected for signs of wear or damage at least once a month.

Replace the tire if:

- The indicators at three or more places around the tire can be seen.
- There is cord or fabric showing through the tire's rubber.
- The tread or sidewall is cracked, cut, or snagged deep enough to show cord or fabric.
- The tire has a bump, bulge, or split.
- The tire has a puncture, cut, or other damage that cannot be repaired well because of the size or location of the damage.

When It Is Time for New Tires

Factors such as maintenance, temperatures, driving speeds, vehicle loading, and road conditions affect the wear rate of the tires.

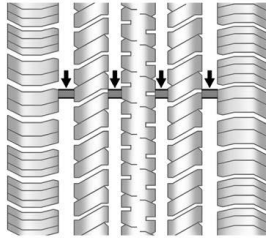

Tread wear indicators are one way to tell when it is time for new tires. Tread wear indicators appear when the tires have only 1.6mm (1/16 in) or less of tread remaining.

The rubber in tires ages over time. Multiple factors including temperatures, loading conditions, and inflation pressure maintenance affect how fast aging takes place. Vanderhall recommends that tires be replaced after six years, regardless of tread wear. The tire manufacture date is the last four digits of the DOT Tire Identification Number (TIN) which is molded into one side of the tire sidewall. The first two digits

represent the week (01–52) and the last two digits, the year. For example, the third week of the year 2010 would have a four-digit DOT date of 0310

Buying New Tires

Vanderhall has developed and matched specific tires for the vehicle. The original equipment tires installed were designed to meet specific Tire Performance Criteria Specification (TPC Spec) system rating. When replacement tires are needed, Vanderhall strongly recommends buying the same manufacture and model tire as the original.

Jump Starting

Jump Starting

For more information about the vehicle battery, SEE BATTERY ⇒ 86.

If the battery has run down, try to use another vehicle and some jumper cables to start your vehicle. Be sure to use the following steps to do it safely.

Caution

Ignoring these steps could result in costly damage to the vehicle. Trying to start the vehicle by pushing or pulling it will not work, and it could damage the vehicle.

1. Check the other vehicle. It must have a 12-volt battery with a negative ground system.
2. Position the two vehicles so that they are not touching.

3. Set the parking brake firmly and put the shift lever in P (Park) SEE SHIFTING INTO PARK ⇒ 56

Caution

If any accessories are left on or plugged in during the jump starting procedure, they could be damaged. Whenever possible, turn off or unplug all accessories connected to either vehicle before jump starting.

4. Turn the ignition to LOCK/OFF. Turn off all lights and accessories in both vehicles, except the hazard warning flashers if needed.
5. Connect one end of the red positive (+) cable to the positive (+) terminal on the discharged battery.
6. Connect the other end of the red positive (+) cable to the positive (+) terminal of the good battery.
7. Connect one end of the black negative (-) cable to the negative (-) terminal of the good battery
8. Connect the other end of the black negative (-) cable to the negative (-) post for the discharged battery
9. Start the engine in the vehicle with the good battery and run the engine at idle speed for at least four minutes.
10. Disconnect the jumper cables in the reverse order (Step 8-5)
11. Try to start the vehicle that had the dead battery. If it will not start after a few tries, it probably needs service.

! Warning

An electric fan can start up even when the engine is not running and can injure you. Keep hands, clothing, and tools away from any under hood electric fan.

97

There are two possible jump start locations

First:

Remove the hood and use the Jump start posts with in the Engine bay

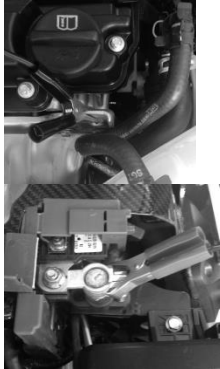

Negative

Positive

SEE ENGINE COMPARTMENT ⇨ 72

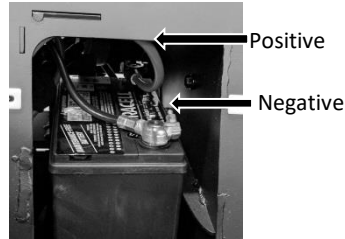

Alternatively if removing the hood is not possible,

1. Slide the passenger seat fully forward.
2. Remove the Battery compartment door.
3. Connecting the Positive jumpstart cable to the Positive (Rear most) battery terminal.
4. Connecting the negative jumpstart cable to the Negative (Forward most) battery Terminal

Appearance Care

Exterior Care

Washing the Vehicle

To preserve the vehicle's finish, wash it often and out of direct sunlight.

Caution
Do not use petroleum-based, acidic, or abrasive cleaning agents as they can damage the vehicle's paint, or metal parts. Follow all manufacturer directions regarding correct product usage, necessary safety precautions, and appropriate disposal of any vehicle care product.

The  symbol is on any underhood compartment electrical center that should not be power washed.

Rinse the vehicle well, before washing to remove and loosen road grit and bugs.

Hand wash the vehicle using a non-abrasive cleaner marked safe for painted surfaces. Rinse the area immediately with cool clean water.

Do not allow cleaning agents to dry on the surface, they could stain. Dry the finish with a soft, clean chamois or an all-cotton towel to avoid surface scratches and water spotting.

Finish Care

Foreign materials such as calcium chloride and other salts, ice melting agents, road oil and tar, tree sap, bird droppings, chemicals from industrial chimneys, etc., can damage the vehicle's finish if they remain on painted surfaces. Wash the vehicle or affected areas often to prevent damage

Occasional hand waxing or mild polishing should be done to remove residue from the paint finish.

To keep the paint finish looking new, keep the vehicle garaged or covered whenever possible.

Cleaning Exterior Lamps and Emblems

Use only lukewarm or cold water, a soft cloth, and an automotive soap to clean exterior lamps and emblems. Follow instructions under "Washing the Vehicle" previously in this section.

Exterior lighting lenses are made of plastic. Do not clean or wipe them when dry as they may scratch and haze. Do not use any of the following on the lenses :

- Abrasive or caustic agents.
 - Washer fluids and other cleaning agents in higher concentrations than suggested by the manufacturer.
- Solvents, alcohols, fuels, or other harsh cleaners.

Windshield

To clean, use a terry cloth fabric dampened with water. Wipe droplets left behind with a clean dry cloth. If necessary, use a commercial glass cleaner after cleaning with plain water.

Cleaning the windshield with water during the first three to six months of ownership will reduce tendency to fog.

Caution

Use caution when cleaning the windshield. Excessive force. Especially if placed on the upper edge of the windshield can cause it to crack.

Gentle pressure should be used when cleaning the windshield

Tires

Use a stiff brush with tire cleaner to clean the tires.

Caution

Using petroleum-based tire dressing products on the vehicle may damage the paint finish and/ or tires. When applying a tire dressing, always wipe off any overspray from all painted surfaces on the vehicle.

Wheels

Use a soft, clean cloth with mild soap and water to clean the wheels. After rinsing thoroughly with clean water, dry with a soft, clean towel. A wax may then be applied.

Caution

To avoid surface damage, do not use strong soaps, chemicals, abrasive polishes, cleaners, brushes, or cleaners that contain acid

Brake System

Visually inspect brake lines and hoses for proper hook-up, binding, leaks, cracks, chafing, etc. Inspect disc brake pads for wear and rotors for surface condition. Inspect other brake parts, calipers, parking brake, master cylinder, brake fluid reservoir, vacuum pipes, and electric vacuum pump including vent hose, if equipped.

Steering, Suspension, and Chassis Components

Visually inspect steering, suspension, and chassis components for damaged, loose, or missing parts or signs of wear at least once a year. Inspect power steering for proper hook-up, binding, leaks, cracks, chafing, etc.

Visually check constant velocity joint boots and axle seals for leaks.

Finish Damage

Quickly repair minor chips and scratches with touch-up materials available from Vanderhall Service to avoid further damage. Larger areas of finish damage can be corrected in a body and paint shop. Contact Vanderhall Service prior to getting repairs.

Interior Care

To prevent dirt particle abrasions, regularly clean the vehicle's interior. Immediately remove any soils.

Use a soft bristle brush to remove dust from knobs and crevices on the dash. Using a mild soap solution, immediately remove hand lotions, sunscreen, and insect repellent from all interior surfaces or permanent damage may result.

Use cleaners specifically designed for the surfaces being cleaned to prevent permanent damage. Apply all cleaners directly to the cleaning cloth. Do not spray cleaners on any switches or controls. Remove cleaners quickly.

Before using cleaners, read and follow all safety instructions on the label.

To prevent damage, do not clean the interior using the following cleaners or techniques:

- Never use a razor or any other sharp object to remove soil from any interior surface.
- Never use a brush with stiff bristles.
- Never rub any surface aggressively or with too much pressure.

- Do not use laundry detergents or dishwashing soaps with degreasers.

A concentrated soap solution will create streaks and attract dirt. Do not use solutions that contain strong or caustic soap.

- Do not heavily saturate the upholstery when cleaning
- Do not use solvents or cleaners containing solvents.

Speaker Covers

Vacuum around a speaker cover gently, so that the speaker will not be damaged. Clean spots with water and mild soap on a damp soft cloth

Fabric/Carpet/Leather

Start by vacuuming the surface using a soft brush attachment. If a rotating vacuum brush attachment is being used, only use it on the floor carpet. Before cleaning, gently remove as much of the soil as possible:

- Gently blot liquids with a paper towel. Continue blotting until no more soil can be removed.
- For solid soils, remove as much as possible prior to vacuuming.

To clean:

1. Saturate a clean, lint-free colorfast cloth with water. Microfiber cloth is recommended to prevent lint transfer to the fabric or carpet.
2. Remove excess moisture by gently wringing until water does not drip from the cleaning cloth

3. Start on the outside edge of the soil and gently rub toward the center. Fold the cleaning cloth to a clean area frequently to prevent forcing the soil in to the fabric.
4. Continue gently rubbing the soiled area until there is no longer any color transfer from the soil to the cleaning cloth.
5. If the soil is not completely removed, use a mild soap solution followed only by plain water.

If the soil is not completely removed, it may be necessary to use a commercial upholstery cleaner or spot lifter. Test a small hidden area for colorfastness before using commercial upholstery cleaner or spot lifter. If ring formation occurs, clean the entire fabric or carpet. After cleaning, use a paper towel to blot excess moisture.

Caution
Soaking or saturating leather may cause permanent damage. Wipe excess moisture from these surfaces after cleaning and allow them to dry naturally. Never use heat, steam, or spot removers. Do not use cleaners that contain silicone or wax-based products. Cleaners containing these solvents can permanently change the appearance and feel of leather and are not recommended.

Towing the Vehicle

Towing the Vehicle

Caution
Incorrectly towing a disabled vehicle may cause damage. Do not lash or hook to suspension components. Use the proper straps around the tires to secure the vehicle.

Have the vehicle towed on a flatbed car carrier. A wheel lift tow truck could damage the vehicle. Consult a professional towing service if the disabled vehicle must be towed.



Service and Maintenance

Venice

Service and Maintenance

Maintenance Schedule

	Owner checks
106	Maintenance schedule
106	

Additional Maintenance

	Battery
108	Belt
108	Brakes
108	Fluids
108	Hoses
108	Lamps
108	Shocks
109	

Vehicle Identification

	Vehicle Identification Number
(VIN).....	111

Vehicle Data

	Engine Belt Routing
111	Capacities and Specifications
112	

106

Tires

109

Vehicle care

109

Wheel Alignment

109

Windshield

109

Recommended Fluids

Recommended Fluids

And Lubricants

110

General Information

Your vehicle is an investment. This section describes the required maintenance for the vehicle. Follow this schedule to help protect against major repair expenses resulting from neglect or inadequate maintenance. It may also help to maintain the value of the vehicle if it is sold. It is the responsibility of the owner to have all required maintenance performed.

Caution
Damage caused by improper maintenance can lead to costly repairs. Maintenance intervals, checks, inspections, recommended fluids, and lubricants are important to keep the vehicle in good working condition.

Maintenance Schedule

Owner Checks and Services

Once a Month

- Check the engine oil level. SEE ENGINE OIL ⇨ 74.
- Check the tire inflation pressures. SEE TIRE PRESSURE ⇨ 94.
- Inspect the tires for wear. SEE TIRE INSPECTION ⇨ 95.

Maintenance Schedule

 VANDERHALL	12,000 KM	24,000 KM	36,000 KM	48,000 KM	60,000 KM	72,000 KM	85,000 KM	97,000 KM	109,000 KM	120,000 KM	133,000 KM	145,000 KM	157,000 KM	170,000 KM	1190,000 KM	1205,000 KM	217,000 KM	230,000 KM	1240,000 KM
Check engine oil level. Change engine oil and filter, if needed.	✓	✓	✓	✓	✓	✓	✓	✓	✓	✓	✓	✓	✓	✓	✓	✓	✓	✓	✓
Clean or replace engine air cleaner filter (or every 4 years, whichever occurs first).				✓				✓				✓			✓				✓
Replace spark plugs								✓							✓				
Change automatic transmission fluid.						✓						✓					✓		
Change brake fluid (or every 3 years, whichever occurs first)						✓						✓					✓		
Drain and fill engine cooling system (or every 5 years, whichever comes first).																			✓
Replace timing belt, idler pulley, and timing belt tensioner													✓						
Inspect engine belts for fraying, excessive cracks (or every 10 years, whichever occurs first)																			✓

Maintenance Schedule (Imperial Units)

Maintenance Schedule (Metric Units)

Additional Maintenance and Care

Your vehicle is an investment and caring for it properly may help to avoid future costly repairs. To maintain vehicle performance, additional maintenance services may be required.

The following list is intended to explain the services and conditions to look for that may indicate services are required.

Battery

The battery supplies power to start the engine and operate any additional electrical accessories.

- To avoid break-down or failure to start the vehicle, maintain a battery with full cranking power.

SEE BATTERY ⇨ 86 AND VEHICLE STORAGE ⇨ 87

Belt

- The Belt may need replacing if they squeak or show signs of cracking or splitting.

Brakes

Brakes stop the vehicle and are crucial to safe driving.

Signs of brake wear may include chirping, grinding, or squealing noises, or difficulty stopping.

Fluids

Proper fluid levels and approved fluids protect the vehicle's systems and components. **SEE RECOMMENDED FLUIDS AND LUBRICANTS ⇨ 110**

- Engine oil levels should be monthly.
- Instrument cluster lights may come on to indicate that fluids may be low and need to be filled.

Hoses

Hoses transport fluids and should be regularly inspected to ensure that there are no cracks or leaks.

Lamps

Properly working headlamps, tail lamps, and brake lamps are important to see and be seen on the road.

- Signs that the headlamps need attention include dimming, failure to light, cracking, or damage.
- The brake lamps need to be checked periodically to ensure that they light when braking.

Shocks

Shocks help aid in control for a smoother ride.

- Signs of wear may include steering wheel vibration, bounce/ sway while braking, longer stopping distance, or uneven tire wear.
- Inspect for signs of damage such as leaking, or blown seals

Tires

Tires need to be properly inflated, rotated, and balanced. Maintaining the tires can save money and fuel, and can reduce the risk of tire failure.

- Signs that the tires need to be replaced include three or more visible tread wear indicators; cord or fabric showing through the rubber; cracks or cuts in the tread or sidewall; or a bulge or split in the tire.

Vehicle Care

To help keep the vehicle looking like new the vehicle should be cleaned frequently. For information on how to clean and protect the vehicle's interior and exterior, [SEE INTERIOR CARE ⇨ 100 AND EXTERIOR CARE ⇨ 98.](#)

Wheel Alignment

Wheel alignment is critical for ensuring that the tires deliver optimal wear and performance.

- Signs that the alignment may need to be adjusted include pulling, improper vehicle handling, or unusual tire wear.

Windshield

For safety, appearance, and the best viewing, keep the windshield clean and clear.

Signs of damage include scratches, cracks, and chips.

Recommended Fluids

Recommended Fluids and Lubricants

Fluids and lubricants identified below by name, part number, or specification can be obtained from your dealer.

Usage	Fluid/ Lubricant
Engine Oil	Use only engine oil with the proper SAE viscosity grade. <u>SEE ENGINE OIL ⇨ 74</u>
Engine Coolant	50/50 mixture of clean, drinkable water and use only DEX-COOL® Coolant. <u>SEE ENGINE COOLANT ⇨ 77.</u>
Hydraulic Brake System	DOT 3 Hydraulic Brake Fluid
Automatic Transmission	DEXRON®-VI Automatic Transmission Fluid.
Chassis Lubrication	Lubricant meeting requirements of NLGI #2, Category LB or GC-LB.

Vehicle Identification

Vehicle Identification Number (VIN)

INVALID0XGH190000

This legal identifier is on the front left corner of the chassis, located behind the Wheel. The VIN also appears on the Vehicle Certification and Service Parts labels and certificates of title and registration.

Vehicle Data

Engine Belt Routing

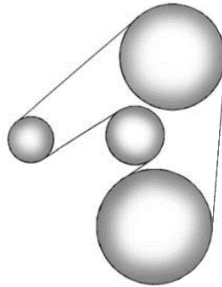

1.4L L4 Engine

Capacities and Specifications

The following approximate capacities are given in metric and English conversions. **SEE RECOMMENDED FLUIDS AND LUBRICANTS ⇒ 110.** For more information

Application	Capacities	
	Metric	English
Air Conditioning Refrigerant	For the air conditioning system refrigerant type and charge amount, see the refrigerant label under the hood	
Cooling System	6.5 L	6.9 qt
Engine Oil with Filter	4.0 L	4.2 qt
Fuel Tank	35 L	9 Gal
Spark Plug Gap	0.60 - 0.70mm	0.024 - 0.028 in
All capacities are approximate. When adding, be sure to fill to the approximate level, as recommended in this manual. Recheck fluid level after filling.		

Customer Information



115

Customer Information

Customer Satisfaction

116

Warranty

116

Radio Frequency Statement

116

Reporting of Safety Defects

116

Vehicle Data Recording
and Privacy

117

Emission System Warranty
Statement (Motorcycle)

117

Customer Satisfaction

Your satisfaction is important to Vanderhall Motorworks. If you should have any concerns with your vehicle please contact the Vanderhall customer service department at info@vanderhallusa.com

Your Vanderhall customer service representative will work closely with you to resolve any issues.

Warranty

Refer to the Vanderhall Venice Warranty document for details

Radio Frequency Statement

This vehicle has systems that operate on a radio frequency that complies with Part 15/Part 18 of the Federal Communications Commission (FCC) rules and with Industry Canada Standards RSS-GEN/210/216/220/251/310, ICES-001.

Operation is subject to the following two conditions:

1. The device may not cause harmful interference.
2. The device must accept any interference received, including interference that may cause undesired operation of the device.

Changes or modifications to any of these systems by other than an authorized service facility could void authorization to use this equipment.

Reporting of safety defects

If you believe that your vehicle has a defect which could cause a crash or could cause injury or death, you should immediately inform the National Highway Traffic Safety Administration (NHTSA) in addition to notifying:

Vanderhall Motorworks,
3500 Mountain Vista Pkwy
Provo, UT 84606
info@vanderhallusa.com

If NHTSA receives similar complaints, it may open an investigation, and if it finds that a safety defect exists in a group of vehicles it may order a recall and remedy campaign. However, NHTSA cannot become involved in individual problems between you and Vanderhall Motorworks.

To contact NHTSA, you may either call the Auto Safety Hotline toll-free at:
1-800-424-9393
or 366-0123 in Washington, D.C. area

or write to: NHTSA, 1200 New Jersey Avenue SE W43-488, Washington, D.C. 20590. You can also obtain other information about motor vehicle safety from the Hotline.

Vehicle Data Recording and Privacy

The vehicle has a number of computers that record information about the vehicle's performance and how it is driven. For example, the vehicle uses computer modules to monitor and control engine and transmission performance this information can be used to provide antilock braking to help the driver control the vehicle. These modules may store data to help the technician service the vehicle. Some modules may also store data about how the vehicle is operated, such as rate of fuel consumption or average speed.

Emission System Warranty Statement (Motorcycle)

DISTRIBUTOR'S LIMITED WARRANTIES EMISSION CONTROL SYSTEMS

The California Air Resources Board and Vanderhall Motor Works are pleased to explain the emission control system warranty on your 2016 motorcycle. In California, new motorcycles must be designed, built and equipped to meet the State's stringent anti-smog standards. Vanderhall Motor Works must warrant the emission control system on your motorcycle for the period of time listed below provided there has been no abuse, neglect, or improper maintenance of your motorcycle.

Your emission control system may include parts such as the carburetor or fuel injection system, the ignition system, catalytic converter, and engine computer. Also included may be hoses, belts, connectors, and other emission related assemblies. Vanderhall Motor Works provides the same warranty coverage to all motorcycle owners, regardless of where the motorcycle is registered.

Your Warranty Rights and obligations:

In the United States new motorcycles must be designed, built and equipped to meet stringent federal anti-smog standards. Vanderhall Motor Works must warrant the emissions control system on your motorcycle for the periods of time listed below, provided there has been no abuse or neglect of your motorcycle. Your emissions control system may include parts such as the sensors, the ignition and the engine

computer. Also included may be hoses, connectors and other emissions-related assemblies. Where a warrantable condition exists, Vanderhall Motor Works will repair your motorcycle at no cost to you, including diagnosis, parts, and labor.

Manufacturer's Warranty Coverage:

If any emissions-related part on your vehicle is defective, the part will be repaired or replaced by Vanderhall Motor Works. This is your emissions control system DEFECTS WARRANTY.

Owner's Warranty Responsibilities:

As the motorcycle owner, you are responsible for the performance of the required maintenance listed in your Owner's Manual. Vanderhall Motor Works recommends that you retain all receipts

covering maintenance on your motorcycle, but Vanderhall Motor Works cannot deny warranty solely for the lack of receipts or for your failure to ensure the performance of all scheduled maintenance. You are responsible for presenting your motorcycle to a Vanderhall Motor Works dealer as soon as a problem exists. The warranty repairs should be completed in a reasonable amount of time, not to exceed, 30 days.

Emission system Warranty Statement (Motorcycle):

As the motorcycle owner, you should also be aware that Vanderhall Motor Works may deny you warranty coverage if your motorcycle or a part has failed due to unapproved modifications. If you have any questions regarding your warranty rights and responsibilities or if an authorized

Vanderhall Motor Works dealer cannot repair your motorcycle or honor your claim within a reasonable period of time, contact Vanderhall Motor Works at info@vanderhallusa.com for assistance. If you are not satisfied with the way in which a warranty claim is resolved by Vanderhall Motor Works, you may write directly to:

Director of Field Operations Support Division (EI4-397F) Environmental Protection Agency

401 M Street, S.W.

California Air Resources Board

9528 Telstar Ave.

El Monte, CA 91731-2990

Emissions Warranty Coverage:

Vanderhall Motor Works warrants to the owner of any 2016 and subsequent model year motorcycle that the motorcycle

applicable emission standards, and is free from defects in materials and workmanship which would cause it to fail to conform with applicable requirements during the specified time and mileage limits.

This warranty begins on the date the motorcycle is delivered to the first purchaser other than an authorized Vanderhall Motor Works motorcycle dealer, or the date it is first used as a demonstrator, lease, or company motorcycle, whichever comes first and continues for the time and mileage listed below:

Time: 5 years

Mileage: 30,000 km (18,600 miles)

These warranties are given only to the owner of a 2016 and subsequent model year motorcycle distributed by

Emission System warranty Statement (Motorcycle):

To qualify for coverage under the defects warranty you should operate and maintain your motorcycle according to the requirements of the Warranty Booklet, and the Maintenance Schedule in the Owner's Manual. This schedule is designed to keep your motorcycle emission control systems functioning properly by maintaining your motorcycle in peak operating condition. Vanderhall Motor Works will not deny a warranty claim solely because of lack of maintenance records. However, failures caused by unapproved modifications will not be covered by this warranty.

Vanderhall Motor Works recommends that only parts supplied by Vanderhall Motor Works or equivalent parts be used to repair your motorcycle. Maintenance,

designed, built and equipped to conform at the time of sale with all systems may be done by any motorcycle repair establishment or individual. Vanderhall Motor Works will only pay for warranty repairs performed at an authorized Vanderhall Motor Works motorcycle repair facility (except in an emergency situation). An emergency situation exists when a Vanderhall Motor Works dealership is not reasonably available, a warranted part is not available within 30 days, or when an authorized Vanderhall Motor Works facility is unable to complete a repair within 30 days. In an emergency situation, the repair of emission control devices or system may be done by any motorcycle repair establishment or individual, or by the owner, using any replacement part. Vanderhall Motor Works will reimburse you for those emergency repairs, including diagnosis, covered by the Emissions Warranties. Parts reimbursement is at the manufacturer's

Vanderhall Motor Works.

suggested retail price, and labor reimbursement is at a geographically-appropriate hourly labor rate for Vanderhall Motor Works recommended time allowance. For reimbursement, present the replaced parts and a copy of the paid receipt to Vanderhall Motor Works.

The use of replacement parts not equivalent to the original parts may impair the effectiveness of your motorcycle's emissions control systems. If such a replacement part is used in the maintenance or repair of your motorcycle, and an authorized Vanderhall Motor Works dealer determines it is defective or caused a failure of a warranted part, your claim for repair to bring your motorcycle into compliance with applicable standards may be denied. If the part in question is not related to the reason your motorcycle

replacement, or repair of emission control devices and

122

fails to meet the standards, your claim will
not be denied.

- Accessories and Modifications 62
- Accessory Power.....13, 19, 28, 44
- Air Filter 67
- Battery 74
 - Jump starting 83
 - Load Management..... 43
 - Power Protection..... 44
- Brakes
 - ABS Warning Light 36
 - Antilock Brake System 53
 - Antilock Brake System Light 36
 - Brake System Warning Light 35
 - Fluid 72
 - Pads 71
 - Pedal Travel 71
- Calibrating Vehicle Speed 33
- California Perchlorate 62
- California Proposition 65 62
- Capacities and Specifications..... 100
- Check Engine Light..... *See* Malfunction Indicator Lamp
- Circuit Breakers 76
- Climate Control..... 38
- Heater Fan Speed 13
- Heater Temperature 13
- Quick Start 16
- Clock 34
 - Adjusting Time..... 34
- Cruise Control
 - Activation..... 13, 55
 - Indicator Light..... 37
 - Setting Cruise Control..... 55
 - Speed Adjustment 13, 55
- Customer Satisfaction..... 103
- Data Link Connector 13, 34, 79
- Electrical System..... 76
- Emissions Inspection..... 34
- Engine Belt Routing 99
- Engine Compartment..... 63
- Engine Coolant..... 67
- Engine Oil..... 65
 - Checking 65
- Engine Overheating 70
- Exterior Care 85
 - Emblems 85
 - Finish Care 85
- Lamps..... 85
- Tires 86
- Washing the Vehicle 85
- Wheels 86
- Windshield..... 86
- Exterior Lighting..... 75
- Fuel 57
 - Filling the Tank..... 57
- Fuel Gauge 31
 - Low Fuel Warning Light 31
- Fuses 76
 - Engine Compartment Fuse Block.. 77
 - Instrument Panel Fuse Block 79
- Gas..... *See* Fuel
- Hazard Warning Flashers 13, 42
- Heated Seats.....13, 15, 22, 38
- High-Beam
 - Indicator Light 37
 - Momentary..... 42
 - Switch 13, 42
- Hood 62
- Horn.....13, 28, 78, 80
- Ignition Switch 12, 13, 39

124		
Positions	48	
Interior Care	88	
Upholstery	89	
Jump Starting.....	83	
Maintenance.....	34	
Maintenance and Care	96	
Maintenance Schedule	See	
Malfunction Indicator Lamp		
Enabling and Disabling Alert	33	
Overview.....	32	
Mirror		
Adjustment	16	
New Vehicle Break-In	48	
Power Outlet	19, 28, 50	
Quick Start Guide.....	14	
Recommended Fluids and Lubricants	98	
Safety Belts	15, 21, 23	
How To Wear Properly	24	
Securing Lap and Shoulder Belt	24	
		Unlatching..... 25
		Why Safety Belts Work
		23
		Seat Adjustment
		15, 22
		Speedometer
		13, 31, 33, 34
		Starting the Engine
		49
		Quick Start
		17
		Steering Wheel
		Adjustment
		13, 16, 28
		Stereo
		Bluetooth
		39
		Controls
		13, 39
		Paring Devices.....
		39
		Tachometer
		13, 31
		Tires
		Buying New Tires
		82
		Cleaning.....
		86
		Tire Inspection
		82
		Tire Pressure
		81
		Towing the Vehicle
		90
		Traction Control.....
		47, 54
		Active Light
		37
		Off Indicator Light.....
		36
		Switch
		13
		Transmission
		51
		Fluid
		67
		Manual Mode
		17, 52
		Quick Start
		17
		Shifting Into Park
		50
		Shifting out of Park
		50
		Trunk.....
		19
		Turn Signal
		Chime.....
		43
		Lever
		13, 43
		Vehicle Identification Number
		99
		Vehicle Storage
		75
		Warranty.....
		103